



**Diamond Machining Technology**

85 Hayes Memorial Drive, Marlborough, MA 01752

Tel: 800.666.4368 or 508.481.5944

Fax: 508.485.3924

DMTCustomerCare@acmeunited.com

[www.dmtsharp.com](http://www.dmtsharp.com)



Facebook.com/  
DMTsharp



Twitter.com/  
DMTsharp



YouTube.com/  
diaDMT



Pinterest.com/  
DMTsharp

DMT is a division of Acme United Corporation  
©2019 Acme United Corporation

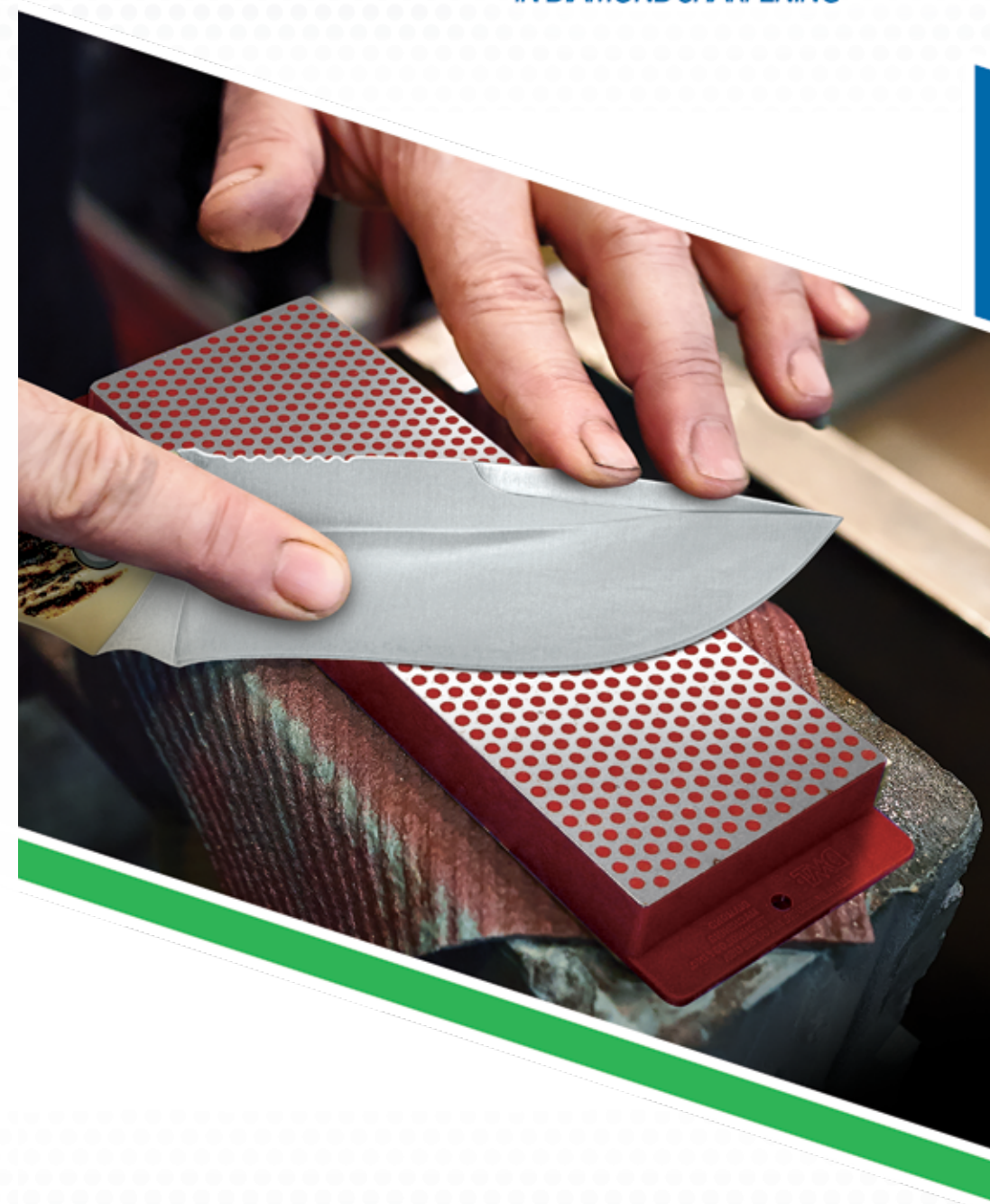

# PRODUCT CATALOG

# DMT's Commitment

MADE IN  
 USA  
SINCE 1976

## To All Who Share Our Enthusiasm for Sharpening

We understand that when you purchase a world-class diamond sharpener you expect your investment to provide many years of reliable performance, but at DMT® we're looking to exceed that expectation. We want to develop a long-standing relationship with you—a partnership for a lifetime of sharpening excellence. In order for this to happen, we have to make sure that you achieve the best possible results from day one, and enjoy continued success as you expand your sharpening needs. That's why, as an industry leader, we are set up to do more than just help you choose the right sharpener for every job; we provide ongoing education, tutorials, video demonstrations and more. Just go on line any time, or call us during business hours to speak with a real person.

## Table of Contents

A World of Difference .....	4-5
Bench Stones .....	6-8
Diamond Whetstone™ Sharpeners .....	6
DuoSharp® Sharpeners .....	7
Dia-Sharp® Sharpeners .....	8
Cones & Accessories .....	9
Portable Sharpeners .....	10-11
Diafold® Sharpeners .....	10-11
Slydr-Sharp™ .....	10
Diamond-Vee® .....	10
HC™ Double-Sided Diafold® .....	11
Pocket Sharpeners .....	12-13
Mini-Sharp® .....	12
SURVIVAL-Sharp™ .....	13
EDC-Sharp™ .....	13
Diamond Whetstone™ Sharpeners .....	12-13
Dia-Sharp® Sharpeners .....	13
Guided Sharpening .....	14-15
Countertop Sharpeners.....	16
Simple-Sharp™ .....	16
Sonic-Sharp™ .....	16
Sharpening Steels .....	17
Lapping .....	18
DMT Grit System.....	19
Sharpening Instructions.....	20-21
Index .....	22-23

*Please take a look at our complete line of superior sharpening products, and contact us any time by phone or email, or visit us on the web at [www.dmtsharp.com](http://www.dmtsharp.com)*



*Diamond abrasives provide the fastest, easiest and most effective way to sharpen an edge. Unrivaled in both performance and durability, DMT® brand sharpeners have earned the reputation as the best sharpening products on the planet.*

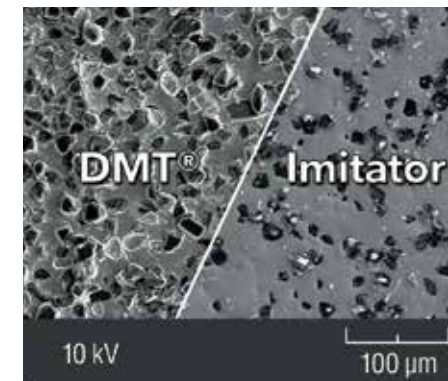

**Beware of imitators!**

*The DMT® sharpening surface (left) exhibits full coverage and the diamonds show striking consistency in size to ensure peak performance and durability. The copycat surface (right) carries a sparse, patchy coating made from a jumble of different sized diamonds.*

# A World of Difference

**The DMT® Difference**

Since 1976, DMT® has been in business to do just one thing: make the world's best diamond sharpeners. Product innovations with our signature polka-dot interrupted surface, as well as our continuous surface of high-performance diamond, are praised worldwide for their superior quality. From pocket-sized whetstones to heavy-duty bench stones, the DMT® Difference shows time and again through our undivided pursuit of sharpening excellence.

**The Innovations Never Stop**

Sharpening technology has been around since the Bronze Age, so one might think that by now there's not much left to improve. And yet for DMT®, the innovations just keep coming. In 1976, we introduced the first interrupted diamond sharpening surface—the signature polka-dot design that ensures cleaner, more efficient sharpening. From there, we introduced our best-selling Diafold® sharpener, followed by the high-tech DuoSharp® line, then the Diamond Wave™ and our patented Magna-Guide® sharpening system. Now, we're proud to introduce our latest design inspiration of handheld and countertop sharpeners.

**Quality Must Be Manufactured, Not Fabricated**

**Diamond Coverage** differs widely from one manufacturer to the next. For long-lasting performance, DMT® makes certain that each sharpening surface carries the most diamonds per square inch in the industry.

**Diamond Uniformity** is also key to sharpener performance. DMT® uses a proprietary process that ensures near-perfect consistency in grit size. The result is a micronized monocrystalline diamond that covers evenly across the sharpening surface to prove effective with every use, year after year.

**Surface Flatness** can mean the difference between a well-honed tool and one that is barely serviceable. Flat surfaces maintain consistent, even contact with the edge to produce a bevel that carries the same degree of sharpness from end to end. DMT® sharpeners are engineered to be the flattest on the market, and built to outlast other products, which are variable in surface, and often warped, hollowed or grooved.

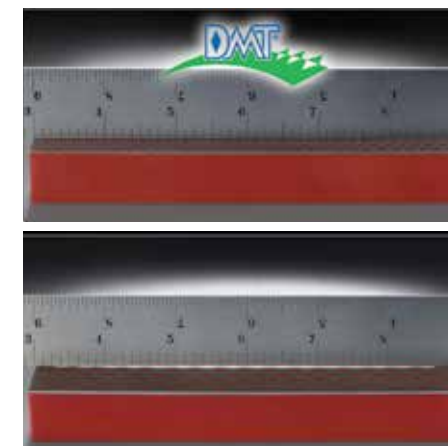

**DMT® gives it to you straight.**

*Like all DMT® sharpeners, the Diamond Whetstone™ (top) proves flat every time. When tested against a precision straight edge, no light appears between the sharpening surface and straight edge. The copycat whetstone (bottom) may look similar to a Diamond Whetstone™, but when tested for flatness the difference is obvious. The light shines through to reveal a surface that fails to prove flat.*

**Start Experiencing the Difference Today**

When compared under every condition related to diamond quality and sharpener performance, it becomes clear that DMT® products truly have no competition. Proving more than just the best way to produce a first-rate edge, our sharpeners save you from coping with an entire toolbox of second-rate ones. That's why you owe it to yourself, and your tools, to choose nothing less than a DMT® diamond sharpener.

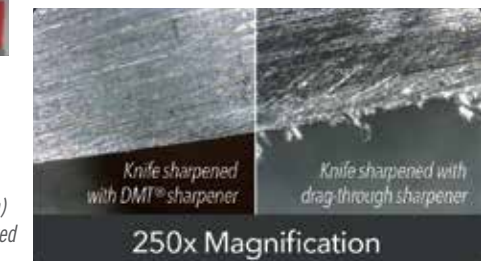

**DMT® vs. Drag-through**

*An edge created by a DMT® sharpener (left) is far superior to one made by a typical drag-through sharpener (right). The DMT® diamond surface produces a clean, razor-sharp edge while the drag-through sharpener leaves a trail of metal burrs that quickly bend and flake off with use.*



# BENCH STONES

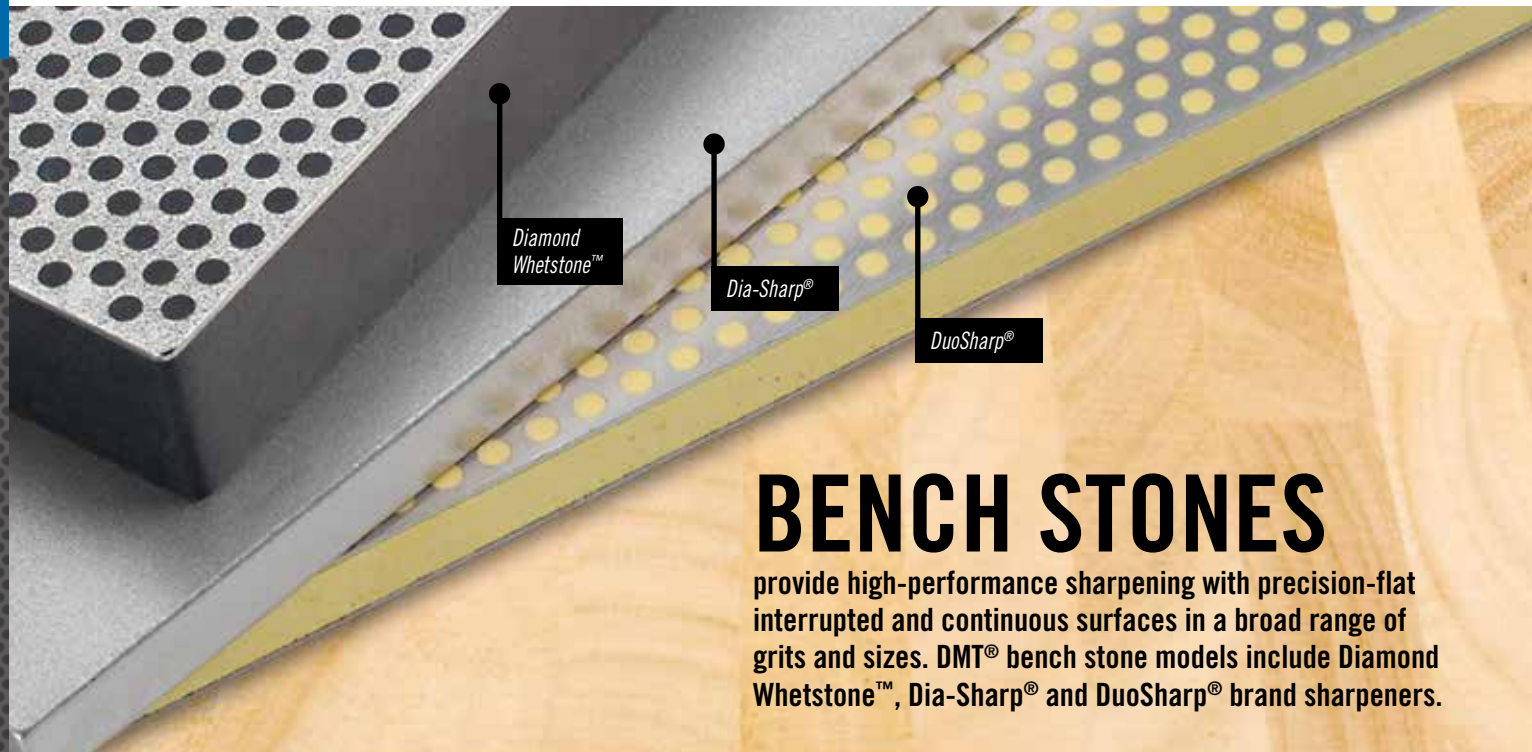

## BENCH STONES

provide high-performance sharpening with precision-flat interrupted and continuous surfaces in a broad range of grits and sizes. DMT® bench stone models include Diamond Whetstone™, Dia-Sharp® and DuoSharp® brand sharpeners.

### Diamond Whetstone™ Sharpeners

Featuring the signature polka-dot pattern innovated by DMT®, Diamond Whetstone™ sharpeners are often imitated in appearance, but never equalled in quality or performance. The interrupted surface of tiny wells trap metal debris to ensure clean, continuous edge contact while the superior diamond does its work. For the quickest, cleanest sharpening, there truly is no substitute. Offered in 2 sizes and 4 grits with an attractive hardwood box or optional plastic case on 6-inch models. **A B C D**



Available in:  
X-COARSE COARSE FINE X-FINE  
**W6X W6C W6F W6E**



Available in:  
X-COARSE COARSE FINE X-FINE  
**W6XP W6CP W6FP W6EP**

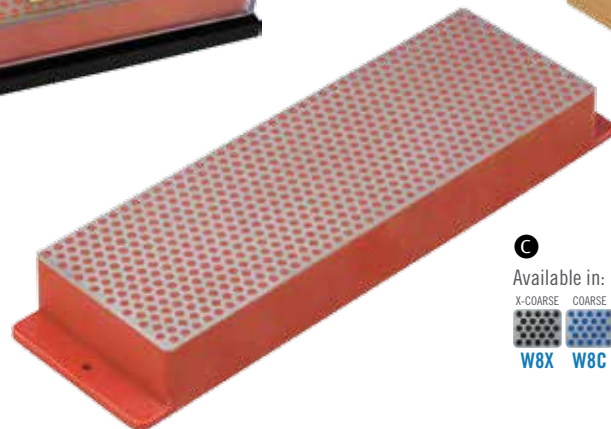

Available in:  
X-COARSE COARSE FINE X-FINE  
**W8X W8C W8F W8E**

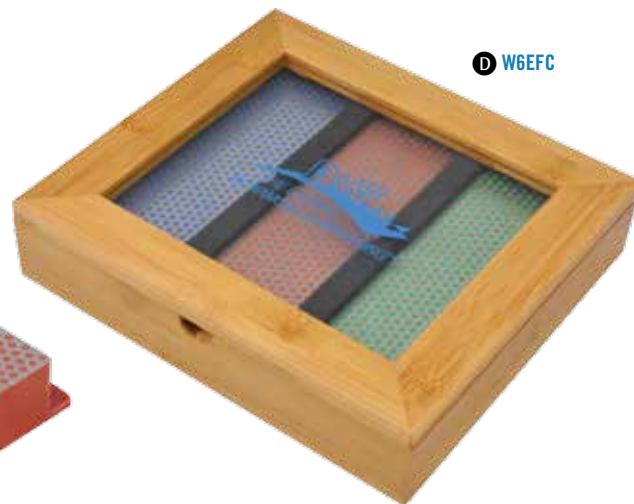

**D W6EFC**



# BENCH STONES

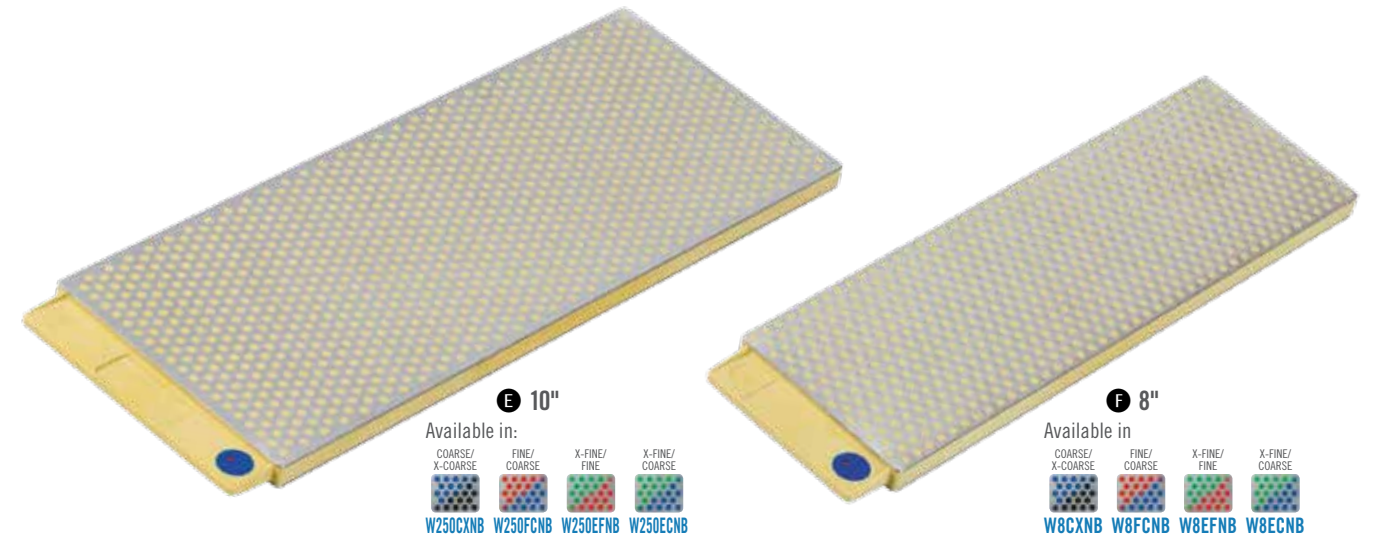

**E 10"**  
Available in:  
COARSE/ X-COARSE FINE/ COARSE X-FINE/ FINE X-FINE/ COARSE  
**W250CXNB W250FCNB W250EFNB W250ECNB**

**F 8"**  
Available in:  
COARSE/ X-COARSE FINE/ COARSE X-FINE/ FINE X-FINE/ COARSE  
**W8CXNB W8FCNB W8EFNB W8ECNB**

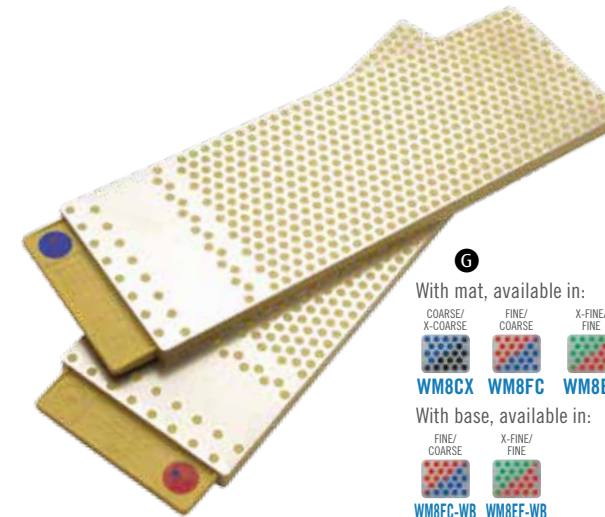

**G**  
With mat, available in:  
COARSE/ X-COARSE FINE/ COARSE X-FINE/ FINE  
**WM8CX WM8FC WM8EF**  
With base, available in:  
FINE/ COARSE X-FINE/ COARSE  
**WM8FC-WB WM8EF-WB**

### DUO SHARP® Sharpeners

Innovative, multi-patented and engineered to be precision-flat, DuoSharp® sharpeners use two interrupted surfaces of superior diamond to provide two-stage sharpening with fast, clean and consistent results every time. Available in 2 sizes and 4 grit combinations, all models come with a base or non-skid mat. **E F H**

### DUO SHARP® Plus™ Sharpeners

These sharpeners have all the features of our DuoSharp® line, plus a continuous zone of diamond abrasive for small and pointed tools. Offered in 4 grit combinations, each includes a base or non-skid mat. **G**

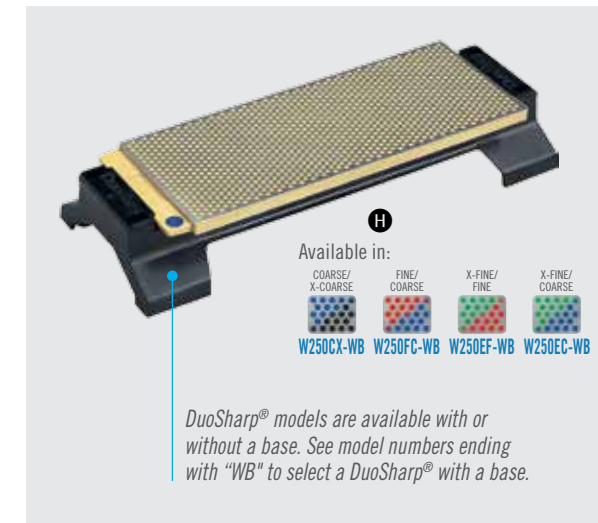

**H**  
Available in:  
COARSE/ X-COARSE FINE/ COARSE X-FINE/ FINE X-FINE/ COARSE  
**W250CX-WB W250FC-WB W250EF-WB W250EC-WB**

DuoSharp® models are available with or without a base. See model numbers ending with "WB" to select a DuoSharp® with a base.

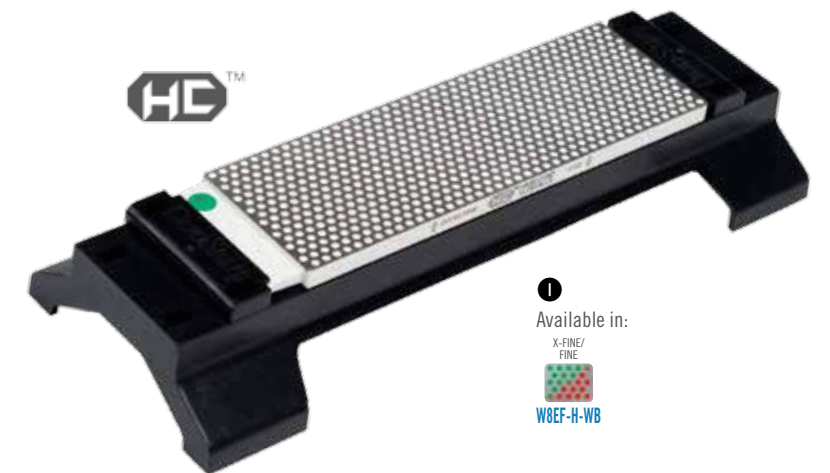

**I**  
Available in:  
X-FINE/ FINE  
**W8EF-H-WB**

### DUO SHARP® HC™

Innovative, multi-patented, and precision-flat, DuoSharp® HC sharpeners make use of two interrupted surfaces of superior diamond HardCoat™ to provide two-stage sharpening with fast, clean and consistent results every time. Features fine and extra-fine grits, plus the handy DuoBase™ for improved ergonomics. **I**





## BENCH STONES



DMT offers a variety of abrasive surfaces and mediums to serve a range of applications.

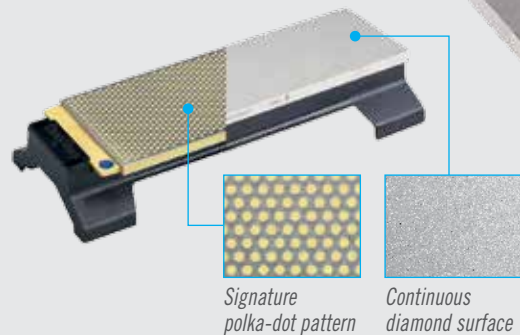

For sharpening, honing and deburring we offer different surfaces to accommodate personal preferences or needs. Our signature polka-dot pattern provides slightly recessed holes to collect metal fines removed during sharpening. This pattern provides a more aggressive removal of material while preventing loading. Some people prefer a more traditional look and feel while they are sharpening and so, DMT offers its continuous diamond surface to accommodate them. This style surface is also perfect for small pointed tools and edges.

DMT's Hardcoat™ technology provides an even more durable surface than our traditional stones. Offered in limited models, two lapping stones and bench and portable models for withstanding the rigors or regular ceramic knife sharpening.

For polishing and refining an edge, DMT's abrasive range includes a 3-micron, 8000 mesh equivalent continuous surface stone and an unbreakable ceramic steel.

Some edges demand a mirror finish. DMT's diamond paste compound and 0.5-micron solution serve to provide the desired finish.

### DIA-SHARP® Bench Stones

For those who prefer a continuous diamond surface, especially for sharpening small or pointed tools, these bench stones outperform them all. Offered in 4 sizes and from 4 to 6 grits, all but double-sided models feature non-skid rubber feet. **A B C D**

### DIA-SHARP® MagnaBase™ Sharpening System

With a full 72 sq. inches of superior diamond, this 12" x 3" double-sided Dia-Sharp® sharpening system includes our DuoBase™ with MagnaBase™ Adapter to deliver the best in 2-stage sharpening. Offered in 2 grit combinations. **E**



The Dia-Sharp® D12 comes with a base for added height. To add a base to any Dia-Sharp®, DuoSharp® or 6" x 2" Diamond Whetstone™, see Accessories on next page.

**A** 11.5"  
Available in:  
X-COARSE COARSE FINE X-FINE  
**D11X D11C D11F D11E**

**B** 10"  
Available in:  
COARSE FINE X-FINE  
**D10C D10F D10E**

**C** 8"  
Available in:  
XX-COARSE X-COARSE COARSE  
FINE X-FINE XX-FINE  
**D8XX D8X D8C  
D8F D8E D8EE**

**D** 6"  
Available in:  
X-COARSE COARSE FINE X-FINE  
COARSE/ X-COARSE FINE/ COARSE X-FINE/ FINE X-COARSE  
**D6X D6C D6F D6E  
D6CX D6FC D6EF D6FX**

**E**  
Available in:  
COARSE/ X-COARSE X-FINE/ FINE  
**D12CX-WB D12EF-WB**

## CONES AND ACCESSORIES



The award-winning design of Diamond Wave™ makes it the most useful and versatile sharpener for a wide range of curved edges, such as gouges, chisels and more.



**G**  
Available in:  
FINE  
**DCSFH**

**H**  
Available in:  
FINE  
**DCMF**

**I**  
Available in:  
FINE  
**DCLF**

**L**  
Available in:  
6 MICRON 3 MICRON 1 MICRON 6.3, 1 MICRON  
**DP6 DP3 DP1 DPK**

**J**  
Available in:  
FINE  
**DCKF**

**K**  
Available in:  
FINE  
**TCKIT-F**

**M** Available in:  
5 MICRON  
**DSPRAY.5**

Add a base to your whetstone, or choose the DuoBase™ with MagnaBase™ Adapter for use with any Dia-Sharp® bench stone.

**P** SR009

**Q** SR009-8

**F**  
Available in:  
FINE X-FINE  
**WAV-F WAV-E**

### Diamond Wave™ Sharpener

The first to combine a convex and concave diamond surface in one, this uniquely designed, award-winning product affords longer, easier sharpening strokes over traditional slip stones. The juxtaposing pair of 1" to 1/16" tapered surfaces produce radii to accommodate a full set of curved edges. Available in 2 grits. **F**

### Diamond Honing Cones

Tapered slip stones are great for honing tool and die sets as well as other curved edges like gouges and specialty instruments. The superior diamond grit of DMT® Diamond Honing Cones ensures faster results with less effort. Offered in 3 sizes, each cone can be purchased separately, or as a kit. **G H I J K**

### Accessories

**Dia-Paste™ Compound:** For achieving ultimate tool performance, there's no substitute for Dia-Paste™ diamond compound. Just a light application produces a polished, mirror finish that reduces friction and extends sharpness. Offered in 3 grits, syringes can be purchased individually or as a kit of 3. **L**

**DiaSpray™ Diamond Suspension:** For those who seek the utmost mirror finish, DiaSpray™ is a sprayable suspension with diamond. This allows the 0.5 micron grit to be easily applied to any stropping material. Available in 1.69 fl. oz (50 ml) bottles. **M**

**DuoBase™ and DuoBase™ with MagnaBase™ Adapter:** Featuring no-skid rubber feet and ample height for knuckle clearance. Choose DuoBase™ for any DuoSharp® or 6" x 2" stone; or select DuoBase™ with MagnaBase™ Adapter for all Dia-Sharp™ models. **N O**

**Non-Skid Mats:** For use with any bench stone up to 10 inches in length, the non-skid mat in both 8-and10-inch, offers a space-saving way to keep your stone in place. **P Q**



# PORTABLE SHARPENERS

## PORTABLE SHARPENERS

put uncompromising diamond performance in a compact, portable design. Our best-selling sharpeners can tackle almost any edge—straight, curved or serrated—and their compact design lets you stow and go!

### Double-Sided Diafold®

Our most popular, versatile and convenient general-purpose sharpener, the Double-Sided Diafold® delivers two-stage sharpening with compact convenience. Two Diamond Whetstone™ sharpeners are combined to create a lightweight sharpener for all sorts of edges, from knives to scissors to axes and more. Models are available in 4 grit combinations. **A**

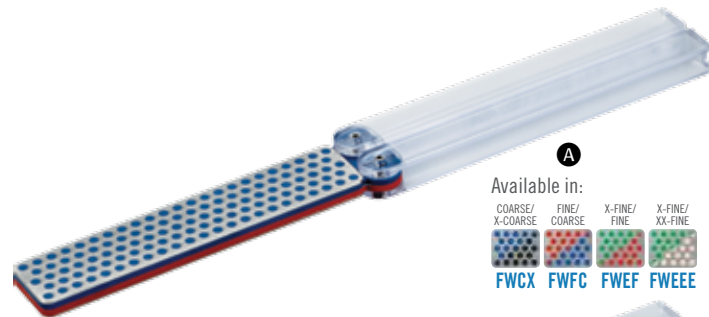

Available in:  
COARSE/ X-COARSE FINE/ COARSE X-FINE/ FINE X-FINE/ XX-FINE  
FWCX FWFC FWEF FWEFE

### Single-Sided Diafold®

Featuring the adaptable Diamond Whetstone™ sharpener with signature polka-dot interrupted surface, Diafold® is truly a multi-use sharpener for the home, camper, tool box and gardening shed. Offered in 4 grits, this trusty tool stores small and performs big. **B**

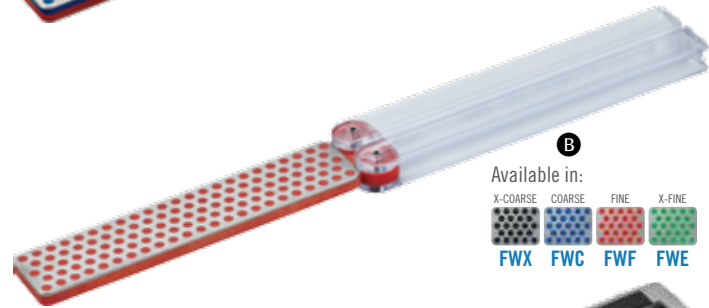

Available in:  
X-COARSE COARSE FINE X-FINE  
FWX FWC FWF FWE

Also available in a grooved hook-and-knife model that allows anglers to sharpen fishhooks. See page 11.

### Slydr-Sharp™

Our first retractable sharpener, handles straight, curved and serrated edges. Slide the diafold sharpener for any straight edge blade or slide the serrated sharpener out for a variety of edges including gut hooks or pruners. The serrated sharpener can also be used as a portable mini-steel. Slydr Sharp is available in fine grit. **C**



Available in:  
FINE  
20000

### DIAMOND-VEE®

A portable sharpener that can be adjusted to different angles depending on your knife or tool. Diamond Vee, a simple pull through sharpener, can be used to handle straight edges. Remove one of the diamond rods and sharpen your serrated edges. When your sharpening is completed, rotate the diamond rods into the handle compartment and store away. Diamond Vee can be adjusted to 10, 15 or 20 degrees. Diamond-Vee is available in fine grit. **D**



Available in:  
FINE  
20004



# PORTABLE SHARPENERS

### Diafold® Serrated Sharpener

Sharpening serrated knives is easy with a Diafold® diamond serrated sharpener. And better still, this foldable companion also serves triple duty as a portable mini-steel, gut hook sharpener and conical file. Available in 3 grits. **E**

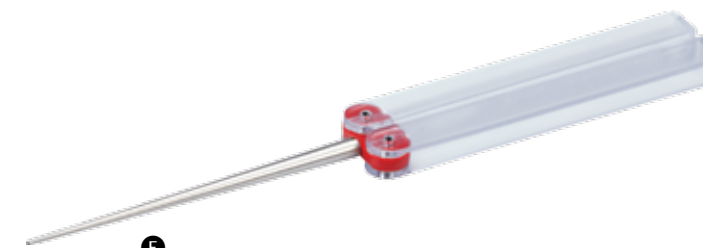

Available in:  
COARSE FINE X-FINE  
FSKC FSKF FSKE

### Diafold® Flat File Sharpener

This single-sided diamond flat file is perfect for confined, narrow applications in the home, shop or garden. And since it's a Diafold® folding sharpener, it stores away small for portable convenience. Offered in 2 grits. **F**

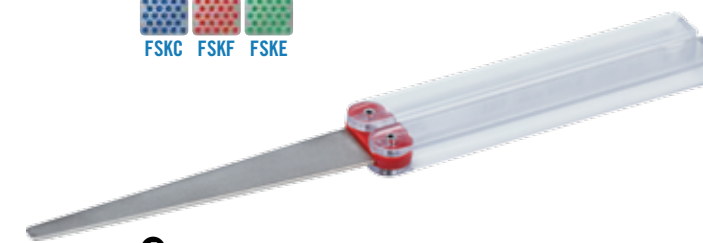

Available in:  
COARSE FINE  
FFC FFF

### Diafold® Chain Saw Sharpener

More than just a workhorse for everyday chain saw maintenance, it's a multi-use tool for getting into all those tight spots. Available in coarse grit and 3 diameters. **G**



Available in:  
7/32" DIA COARSE 6/32" DIA COARSE 5/32" DIA COARSE  
FCS7C FCS6C FCS5C

### Single-Sided Diafold® with Groove

Diamond Whetstone™ sharpener in a grooved hook-and-knife model that allows anglers to sharpen fishhooks. **H**



Available in:  
COARSE FINE  
FFHWC FFHWF

### Double-Sided Diafold® HC™

By combining the Hardcoat™ surface with our most popular, versatile and convenient double-sided sharpener, you get portable two-stage sharpening for not just steel but ceramic edges as well. The fine and extra-fine Diamond Whetstone™ surfaces also feature a continuous zone for use on pointed tools. **I**

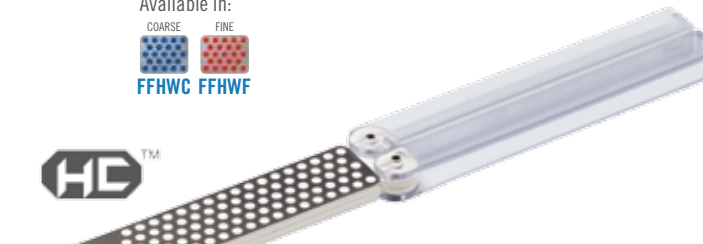

Available in:  
X-FINE/ FINE  
FWMEF-H



Some Diafold® models feature a diamond grit coated groove to easily sharpen fishhooks

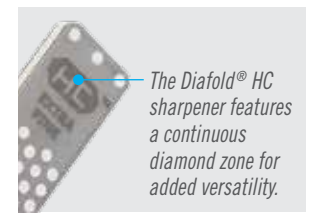

The Diafold® HC sharpener features a continuous diamond zone for added versatility.

Lapping Sharpening Steels Countertop Sharpeners Guided Sharpening Pocket Sharpeners Portable Sharpeners Cones & Accessories Bench Stones

Lapping Sharpening Steels Countertop Sharpeners Guided Sharpening Pocket Sharpeners Portable Sharpeners Cones & Accessories Bench Stones



# POCKET SHARPENERS

## POCKET SHARPENERS

deliver simplicity and utility for sharpening any time, anywhere. Available in both interrupted and continuous diamond surfaces, DMT® pocket models include Mini-Sharp®, Mini-Hone®, Diamond Whetstone™ and Dia-Sharp® brand sharpeners.

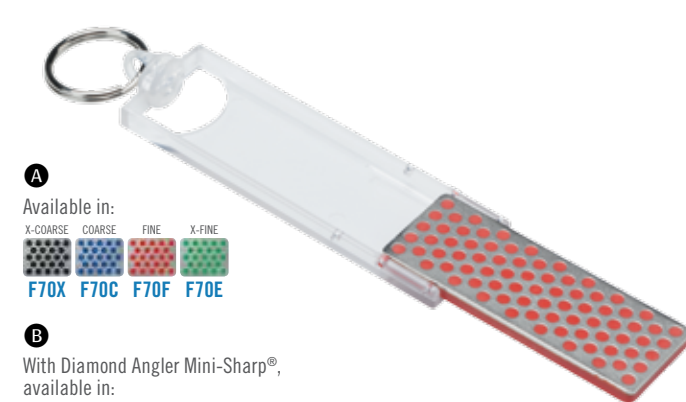

**A** Available in:  
X-COARSE COARSE FINE X-FINE  
F70X F70C F70F F70E

**B** With Diamond Angler Mini-Sharp®, available in:  
COARSE FINE  
FF70C FF70F

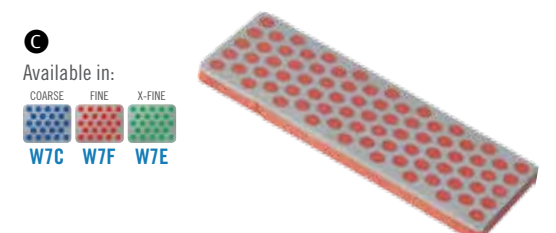

**C** Available in:  
COARSE FINE X-FINE  
W7C W7F W7E



**E** Available in:  
X-COARSE COARSE FINE X-FINE XX-FINE  
W4X W4C W4F W4E W4EE

**F** With continuous zone, available in:  
COARSE FINE X-FINE  
WMC WMF WME

### Diamond Mini-Sharp® Sharpeners

The sharpener that travels with you, Diamond Mini-Sharp® features a folding handle to make it ultra portable, plus a swivel ring that attaches conveniently to a coat, backpack, or key chain. Offered in 4 grits. Also available in a grooved model that allows anglers to sharpen fishhooks. Offered in 2 grits. **A B**

*Mini-Sharp® folds away to just a few inches and the swivel ring keeps it handy for the road or trail.*

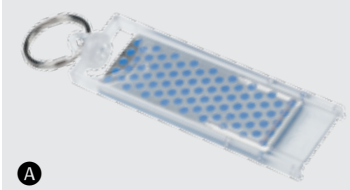

**A**

*Diamond Angler Mini-Sharp® features a grooved edge to easily sharpen fishhooks.*



**B**

### Mini Diamond Whetstone™ Sharpeners

A portable enhancement to any tool bag or glovebox, the 70mm stone delivers quick edge repair any time, anywhere. Available in 3 grits, individually or as a kit of 3. **C D**

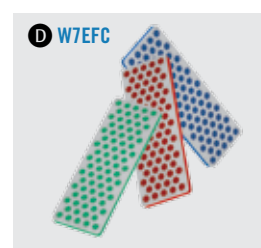

**D** W7EFC

### Diamond Whetstone™ Sharpeners

Surely the most distinguished tool to fit in your pocket, this handy 4" diamond sharpener comes in a handsome leather sheath. Offered in 5 grits, individually or as a kit of 4.

Some models also feature a continuous diamond zone for sharpening pointed or narrow-edged tools. Available in 3 grits. **E F G**



*Some 4-inch Diamond Whetstone™ models feature a continuous diamond zone for added versatility.*



**G** W4K



# POCKET SHARPENERS

### SURVIVAL-Sharp™

Perfect for camping or hiking, Survival Sharp contains a firestarter, diamond sharpener rod and our fine grit diamond polka-dot sharpener. Sharpen any straight, curved or serrated edge in a pinch with Survival Sharp. Use the carabiner to hitch to a backpack or belt loop. **H**

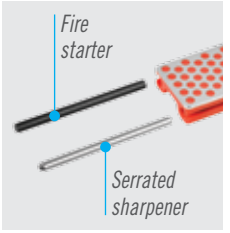

**H** Available in:  
FINE  
20005

**I** Available in:  
FINE  
20006

### EDC-Sharp™

A great everyday carry tool, EDC Sharp is packed with a variety of components for any situation. 2 screwdrivers, lanyard hole, imperial ruler, metric rules, 3 hex wrenches (7, 8, 10mm), wire stripper/cutter, bottle opener, file and diamond sharpener. **I**

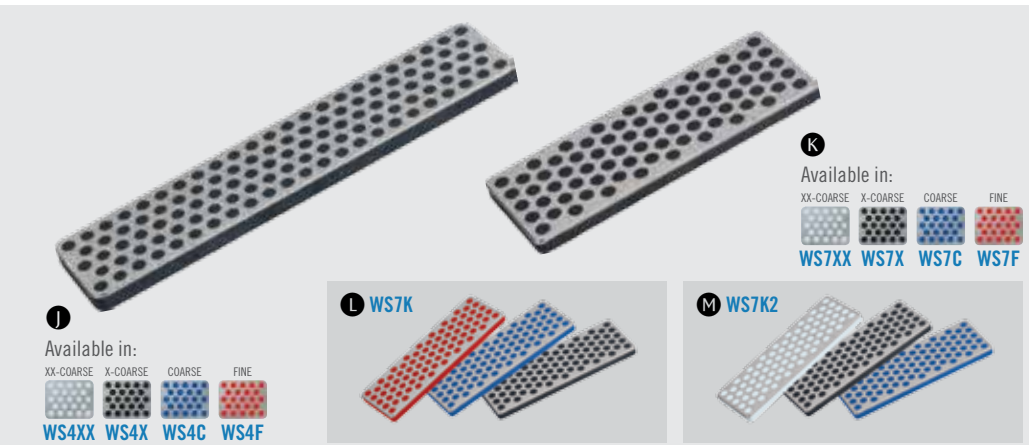

**J** Available in:  
XX-COARSE X-COARSE COARSE FINE  
WS4XX WS4X WS4C WS4F

**K** Available in:  
XX-COARSE X-COARSE COARSE FINE  
WS7XX WS7X WS7C WS7F

### Diamond Whetstone™ Sharpeners

Pocket-sized for the rink or the slopes, our 4" sharpener is available in 4 grits and includes a water resistant pouch. Or lighter still, the 70mm Mini Diamond Whetstone™ fits anywhere and comes in 4 grits, individually or in kits of 3. **L K M**

### DIA-SHARP® Sharpeners

Perfect for small edges and pointed tools, this 4" continuous-surface stone works big in tight spots. Offered in 3 grits. **O**

### DIA-SHARP® Credit Card Sharpeners

For on-the-go edge repair, this sharpener fits nicely in your wallet. Offered in 3 grits, and includes a vinyl carry sleeve. **P Q**



### DIA-SHARP® Mini-Hone® Sharpeners

Suited for tight areas, these continuous-surface stones work well on everyday edges. Straight and offset models are available in 3 grits, individually or in kits of 3. **R S T U**

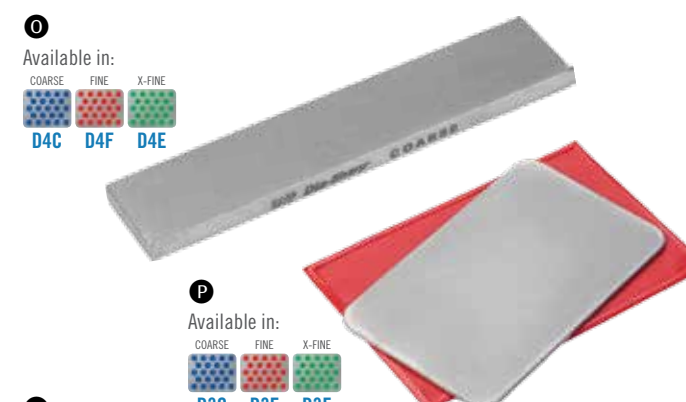
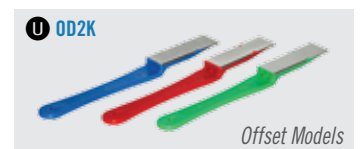

**O** Available in:  
COARSE FINE X-FINE  
D4C D4F D4E

**R** Available in:  
COARSE FINE X-FINE  
D2C D2F D2E

**S** Available in:  
COARSE FINE X-FINE  
OD2C OD2F OD2E



Straight Model



Offset Model



Bench Stones  
Cones & Accessories  
Portable Sharpeners  
Pocket Sharpeners  
Guided Sharpening  
Countertop Sharpeners  
Sharpening Steels  
Lapping

Bench Stones  
Cones & Accessories  
Portable Sharpeners  
Pocket Sharpeners  
Guided Sharpening  
Countertop Sharpeners  
Sharpening Steels  
Lapping



# GUIDED SHARPENING

## GUIDED SHARPENING SYSTEMS

ensure proper edge care by providing consistent results without fail—even for beginners! Available in a wide range of grit combinations, DMT® offers two easy-to-use systems: the Aligner™ and Diafold® Magna-Guide® brand sharpening systems.

### Diafold® Magna-Guide® Kits

This portable, lightweight system consists of 3 elegantly integrated parts: the Double-Sided Diafold® sharpener, Aligner™ blade guide and magnetic angle guide. The Double-Sided Diafold® offers portable, 2-stage sharpening at its best, the blade guide provides 7-angle adjustability for just the right edge every time, and the angle guide joins them by way of its unique built-in magnet. Offered in kits of one or two double-sided sharpeners. The two-sharpener kit (shown left) comes with a rugged carry case. **A B**



### Diafold® Magna-Guide® Kits

Portable, lightweight and easy to use, Diafold® Magna-Guide® lets you hone knives like a pro. Just clamp on the blade guide, choose a sharpening angle, and glide the sharpener along the blade while the angle guide does all the work to keep your angle true.

### Magna-Guide® Components

For those who already own one or more Double-Sided Diafold® sharpeners and wish to make sharpening easy enough for any family member or coworker, DMT® offers the Aligner™ blade guide and magnetic angle guide. With these two simple components, there will never be another dull edge in your house, campsite or workshop. **C**



### C MGUIDE

Turn any Diafold® sharpener into a guided sharpening system with just two easy-to-use components.



# GUIDED SHARPENING

### Aligner™ Easy Edge-Guided Sharpening Kits

Our flagship product for guided sharpening, the Aligner™ provides all the right components to ensure consistent angles, precise edge bevels, and expert sharpening strokes. Carefully designed for the ultimate in fast, faultless knife sharpening, each Aligner™ kit includes one stone holder, one blade guide and a combination of grits and accessories. **D E F G H I J**



### Aligner™ Easy Edge-Guided Sharpening Kits

The Aligner™ is comfortable to grip and easy to use. Just cradle the stone holder in your hand and glide your edge across the stone. Lefty or righty, it works the same for both sides of the blade—just flip it and repeat!

### Aligner™ Components

For those who already own one or more 4" Diamond Whetstone™ sharpeners or otherwise wish to expand the versatility of their Aligner™ kit, DMT® offers individual components and accessories. In addition to the Aligner™ blade guide and stone holder, six grits are available, ranging from extra- extra fine to extra-extra coarse. **K L M N O P**



Each of the sharpeners comes with Aligner™ blade guide and stone holder components.

Lapping Sharpening Steels Countertop Sharpeners Guided Sharpening Pocket Sharpeners Portable Sharpeners Cones & Accessories Bench Stones

Lapping Sharpening Steels Countertop Sharpeners Guided Sharpening Pocket Sharpeners Portable Sharpeners Cones & Accessories Bench Stones





# COUNTERTOP SHARPENERS

## COUNTERTOP SHARPENERS

are hassle-free with no guess work. Our sharpeners' grits are preset to an optimized angle. Just sharpen and it's done.



**A** Available in:  
FINE  
20003

### Simple-Sharp™

Provides an easy way to manually sharpen any straight edge blade. Great for the kitchen, Simple Sharp is set at 22 degrees and simultaneously sharpens both edges of the blade. Insert the blade at the beginning and slide through to the tip for a clean, consistent edge everytime. **A**

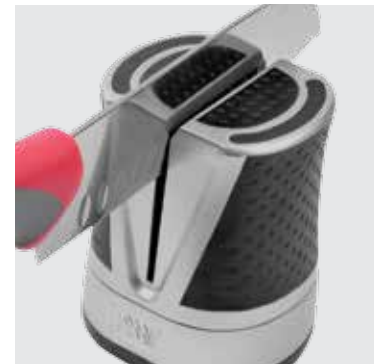

**A** Available in:  
FINE  
20001

### Sonic-Sharp™

Our first battery powered sharpener, requires 2 AA batteries. Sharpen each edge separately by inserting the blade at the beginning and guiding through to the tip. Sonic vibrations provide sharpening assistance, so no extra force is needed. Sonic Sharp is set to 22 degrees. **B**



# SHARPENING STEELS



## SHARPENING STEELS

work well to hone, align and extend the utility of knife edges. More than just a steel, Diamond Steel™ sharpeners feature a high-performance diamond surface that can truly sharpen a dulled knife to its peak condition.



**C** 14"  
Available in:  
FINE  
DS4F

**D** 12"  
Available in:  
FINE  
DS2F

**E** 12"  
Available in:  
X-FINE  
DS2E

**F** 10"  
Available in:  
FINE  
DS0F

**G** 12"  
CS2

### Diamond Steel™ Sharpeners

Providing more than just the realigning function of a traditional butcher steel, the Diamond Steel™ utilizes a fast-honing diamond surface to quickly and conveniently produce sharper results. Each rod features a sanitary, single-piece plastic handle with hand guard and a color-coded ring for easy grit identification. Offered in 3 sizes and 2 grits.

**C D E F**

### Ceramic Steel

Through a patented process, the DMT® Ceramic Steel combines the fine abrasiveness of ceramic with lightweight aluminum to deliver a shatterproof, wear-resistant tool that provides the finest polished edge achievable by a bonded abrasive. With every convenience of a traditional butcher steel, this professional-grade product also features a sanitary, single-piece plastic handle with hand guard. **G**



All DMT® steels feature a sanitary, single-piece molded handle with 4-lobed guard for protection while in use and no-roll stability when rested on a countertop or prep surface.



The multi-purpose Crystal Saver® is a coarse-grit sharpener that can really save the day when mishaps occur. Designed to repair delicate crystal, this little hero works just as well on a dull paring knife.

**H** 4.5"  
Available in:  
COARSE  
COO

### Crystal Saver® Multi-Purpose Sharpener

Its name is Crystal Saver®, but it does so much more than repair chipped crystal, glass and stoneware. This handy tool features a half-round diamond surface coarse enough to bring back the edge to almost anything in your kitchen drawer. For uncompromising results on small knives, use it in 2-stage sharpening along with a Diamond Steel™ or other fine-grit DMT® sharpener. **H**



Lapping  
Sharpening Steels  
Countertop Sharpeners  
Guided Sharpening  
Pocket Sharpeners  
Portable Sharpeners  
Cones & Accessories  
Bench Stones

Lapping  
Sharpening Steels  
Countertop Sharpeners  
Guided Sharpening  
Pocket Sharpeners  
Portable Sharpeners  
Cones & Accessories  
Bench Stones



# LAPPING

## LAPPING

is an often overlooked yet critical part of proper edge care. While DMT® diamond sharpeners hold their flatness over continued use, traditional stones such as waterstones, oilstones and Arkansas stones need regular flattening to perform properly. Dia-Flat® brand lapping plates utilize proprietary DMT® Diamond Hardcoat Technology™ and have extreme flatness to be effective on all types of traditional stones, large or small.

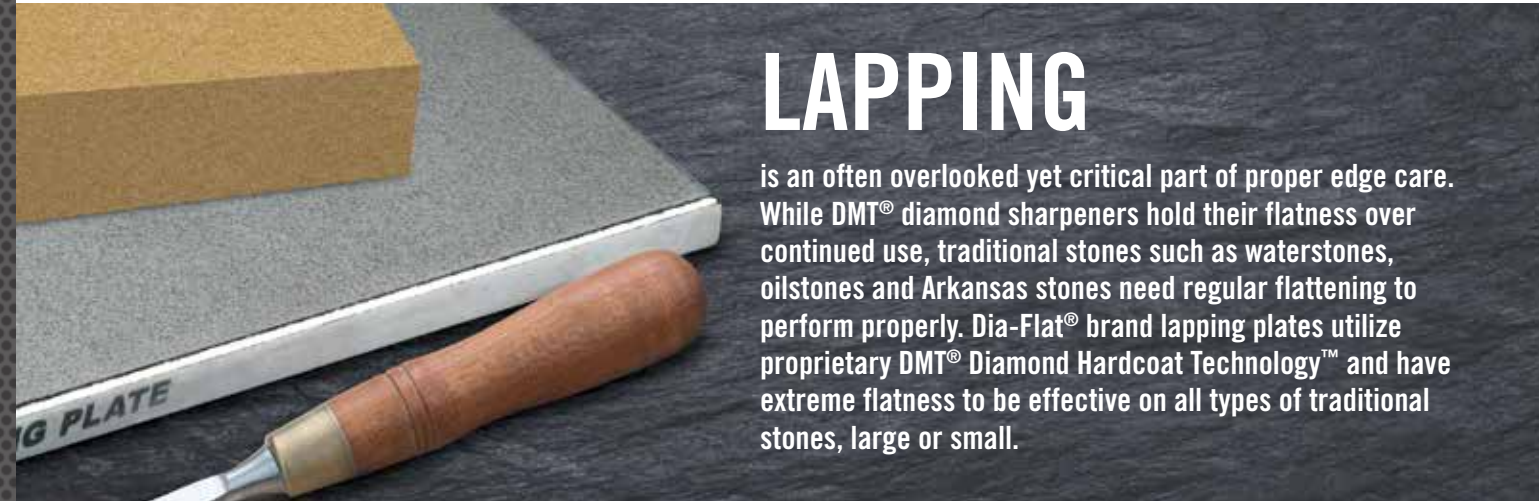

**A**  
Available in:  
120 MICRON  
95 MICRON  
**DIAFLAT DIAFLAT-95**

### Dia-Flat® Lapping Plate

The undisputed heavyweight champion above all other bonded abrasive products, this extraordinary tool is unmatched for bringing flatness back to any conventional waterstone, oilstone or Arkansas stone. No other product or method performs the job in less time or with less effort because only Dia-Flat® features the revolutionary new DMT® Diamond Hardcoat Technology™ surface with the option of either 120- or 95-micron diamond grit.

Manufactured to outlast any other diamond coated product on the market, each Dia-Flat® Lapping Plate is precision-ground to carry a consistent, even coating of micronized monocrystalline diamond, then hand-certified to prove flat to less than ±0.0005 inches. The ample surface area of 40 square inches allows easy flattening of both large and small stones. **A**

*Manufactured to exacting tolerance, Dia-Flat® Lapping Plates are hand certified, so each product arrives with its own certificate verifying absolute flatness to a variance of <math>\pm 0.0005</math> inches.*

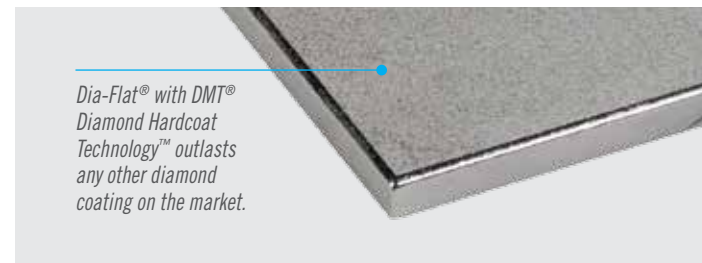

*Dia-Flat® with DMT® Diamond Hardcoat Technology™ outlasts any other diamond coating on the market.*

# DMT GRIT SYSTEM



## WHICH GRIT SHOULD I USE?

This very good question is exactly why we pioneered the color-coding system for the sharpening industry. Colors provide quick and consistent identification, plus they help emphasize just how easy it can be to make the right choice. Grit selection should be based on just three factors:

- 1 The type of tool to be sharpened
- 2 The condition of its edge
- 3 Your desired level of sharpness. For professional results, choose at least two grits so you can step from the coarser to finer surfaces as you sharpen. Or choose a Double-Sided Diafold® or DuoSharp® sharpener, which have two sides to give you a pair of grits in every product. Whichever your preference, the chart below will help you select the optimal grits.



*Always look for the DMT® logo to be sure you're buying the genuine DMT® diamond surface.*

*If you're still not sure, just call Customer Service at 800-666-4368 or 508-481-5944 during regular business hours, Monday through Friday, 8:00 a.m. to 5:00 p.m. EST.*

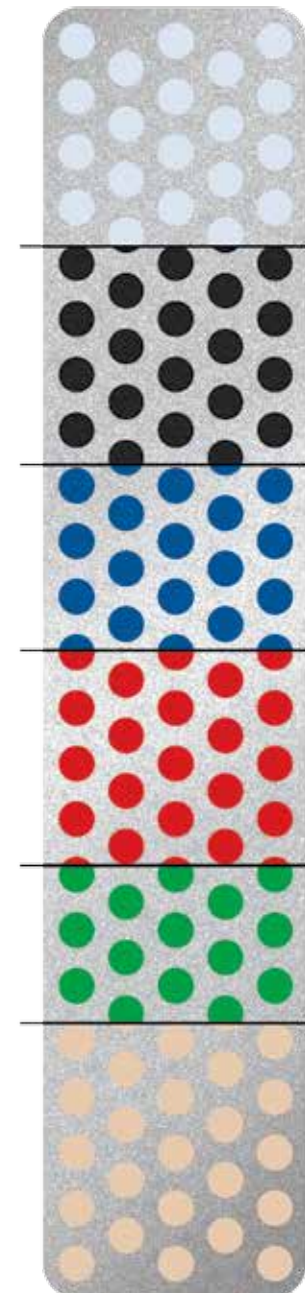

### Extra Extra Coarse

**Aggressive edge repair when bringing a tool back from what looks like the end of life —a safe alternative to powered grinding.**

Recommended for extreme stock removal to repair a much damaged edge or to quickly change a bevel angle. This grit is a safe alternative to power grinding, cutting quickly without heat build-up that can ruin tool temper. Unless the stone is designated Dia-Flat®, do not use for lapping. Size: 120 micron (120 mesh). Color code: silver.

### Extra Coarse

**Use to rapidly repair damaged or real rough edge.**

Recommended for aggressive removal of metal on damaged tools or for heavy-duty outdoor tools such as axes and lawn mower blades. This grit is commonly used as the first step in flattening the backs of chisels and plane irons and for rapid stock removal from a chipped or damaged edge. Unless the stone is designated Dia-Flat®, do not use for lapping. Size: 60 micron (220 mesh). Color code: black.

### Coarse

**Transforms a dull edge to cutting condition.**

Quickly restores a dull edge to cutting sharp. Customers that desire cutting fast action without worry of edge refinement often use our coarse models. Unless the stone is designated Dia-Flat®, do not use for lapping. Size: 45 micron (325 mesh). Color code: blue.

### Fine

**Use to put a great edge on slightly dull knives or tools**

Restores to a fine edge any knife or tool that is slightly dull. Many of our customers consider the fine grit to be a medium/all purpose sharpener. Professional Chefs and gourmet cooks work through to our finer grit models. For woodworkers and sportsman who are stepping through the grits, it's the edge refinement step done before micro beveling and polishing. Size: 25 micron (600 mesh). Color code: red.

### Extra Fine

**Gives everything a polished and razor sharp edge.**

Refines knife or tool edge to razor sharp perfection. Size: 9 micron (1200 mesh). Color code: green.

### Extra Extra Fine

**For the edge enthusiast who wants the ultimate edge.**

Provides the finest grade micronized bonded diamond abrasive available anywhere for the ultimate edge refinement, achieving quick stock removal with millions of diamond cutting edges. Prior to break-in, using the extra-extra fine diamond will result in a matte to shiny finish (scratch pattern evident) on your edge or bevel; once fully broken in, you will achieve a lustrous finished edge. Size: 3 micron (800 mesh). Color code: tan.

## CONVENTIONAL KNIVES (<9")

**Suggested Sharpener:** Aligner™ Easy Edge-Guided Sharpener (shown). Also, MagnaGuide™ Guided Sharpener, Mini-Sharp®, Diafold®, Diamond Whetstone™, DuoSharp®, Dia-Sharp® or Diamond Whetstone™

- 1 Set the 2 opposing clamp eyehooks to the angle of knife bevel, 20° for most edges.
- 2 Attach clamp perpendicular to spine of blade.
- 3 Slide guide rod through eyehook to position sharpener against the bevel of the blade (as shown).
- 4 Lightly stroke away from the body, drawing the knife forward and across the sharpening surface.
- 5 Flip and repeat, using the opposite eyehook with guide rod to maintain the proper bevel angle.
- 6 Progress to finer grits to achieve desired result.

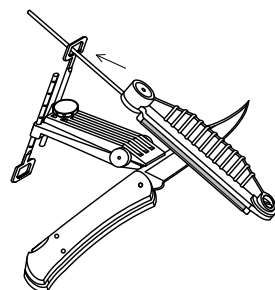

Aligner™ Easy Edge-Guided Sharpener



## LARGER KNIVES (>5")

**Suggested Sharpener:** Diamond Whetstone™ (shown). Also, DuoSharp®, Dia-Sharp®, Diafold® or Diamond Steel™

- 1 Establish proper angle of bevel, 20° for most edges (A).
- 2 Lightly stroke away from the body, drawing the knife forward and across the sharpening surface (B and C).
- 3 Progress to finer grits until desired result.

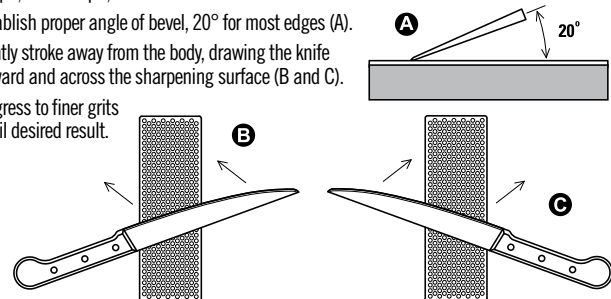

Diamond Whetstone™



## SCISSORS

**Suggested Sharpener:** Diafold® (shown). Also, Diafold® Flat File, Mini-Hone® or Mini-Sharp®

- 1 Align sharpener flush with bevel (A).
- 2 Stroke smoothly toward outside of scissors (B).
- 3 Rotate scissors 180° and repeat.

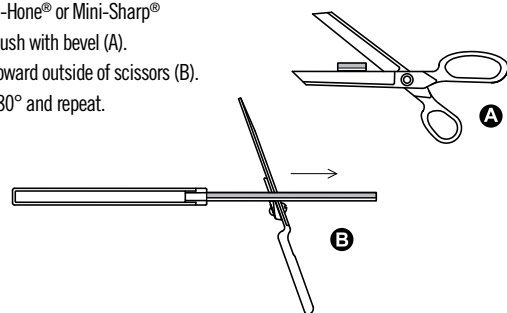

Single- and Double-Sided Diafold®



## PRUNERS

**Suggested Sharpener:** Diafold® Flat File (shown). Also, Diafold®, Mini-Hone® or Mini-Sharp®

- 1 Align sharpener flush with bevel (A).
- 2 Stroke into the bevel edge (B).

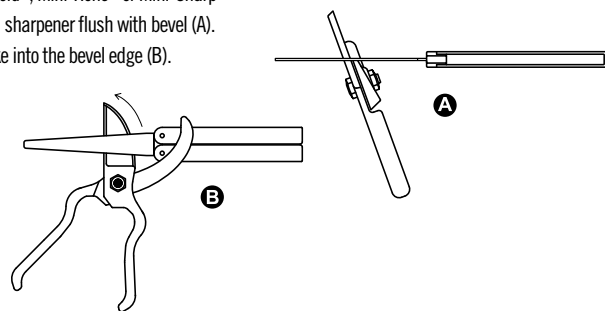

Dia-Flat® Flat File



## SERRATED KNIVES

**Suggested Sharpener:** Diafold® Serrated Sharpener (shown). Also, Aligner™ Guided Systems with Serrated Accessory

- 1 Match diameter of tapered rod to the size of the serration (A).
- 2 Keeping the sharpener flush with the bevel, make half-inch strokes with a twisting motion (B).
- 3 Repeat for each serration.

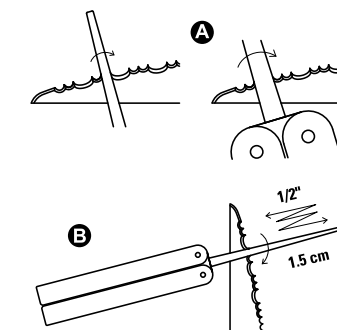

Diafold® Serrated Sharpener



## CHISELS & PLANES

**Suggested Sharpener:** DuoSharp® (shown). Also, Dia-Sharp® or Diamond Whetstone™

- 1 On new or damaged edges, flatten back first (A), working from coarser to finer grits.
- 2 Establish proper angle of bevel using fingers or a sharpening jig to keep the bevel flat on stone.
- 3 Make light, forward strokes until sharp (B).
- 4 Finish with one light stroke on the back side to remove burr.

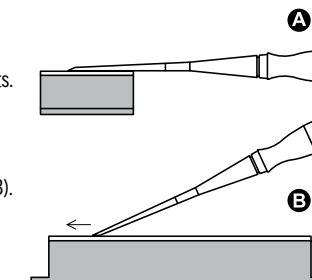

DuoSharp® Bench Stone



## CHAINSAWS

**Suggested Sharpener:** Diafold® Chainsaw Sharpener

- 1 With chain on saw, mark first tooth with marker.
- 2 Match sharpener angle against the concave face of a right-facing cutter (A).
- 3 Stroke inward on each right-facing cutter (B).
- 4 Flip and repeat for all left-facing cutters.

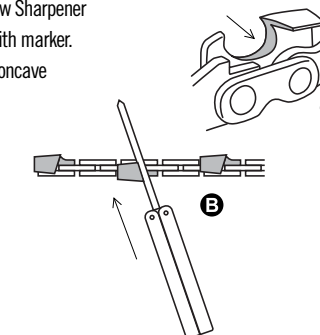

Diafold® Chainsaw Sharpener



## FLATTENING / LAPPING

**Suggested Tool:** Dia-Flat® Lapping Plate.

- 1 With a soft pencil, fill the entire surface of the stone to be flattened with a series of x-marks.
- 2 Either submersed in a pan of water or under a running tap\*, rub the surface to be flattened against the Dia-Flat® Lapping Plate.
- 3 Check the x-marks periodically so you do not remove more material than necessary. When there are no x-marks visible, your surface is finished.

\*NOTE: Never attempt to flatten a stone in a sink that has a garbage disposal as the slurry can damage the disposal's bearings.

Dia-Flat® Lapping Plate





# INDEX

Model Number	Sharpener Size inches (millimeters)	Diamond Grit X=extra, XX=extra-extra	Special Features
<b>BENCH STONES PAGE 6-7</b>			
W6X	6 x 2 (152 x 51)	X-Coarse	Box included
W6C	6 x 2 (152 x 51)	Coarse	Box included
W6F	6 x 2 (152 x 51)	Fine	Box included
W6E	6 x 2 (152 x 51)	X-Fine	Box included
W6XP	6 x 2 (152 x 51)	X-Coarse	Plastic case
W6CP	6 x 2 (152 x 51)	Coarse	Plastic case
W6FP	6 x 2 (152 x 51)	Fine	Plastic case
W6EP	6 x 2 (152 x 51)	X-Fine	Plastic case
W6EFC	6 x 2 (152 x 51)	X-Fine / Fine / Coarse	Box included
W8X	8 x 2.625 (203 x 67)	X-Coarse	Box included
W8C	8 x 2.625 (203 x 67)	Coarse	Box included
W8F	8 x 2.625 (203 x 67)	Fine	Box included
W8E	8 x 2.625 (203 x 67)	X-Fine	Box included
W8CXNB	8 x 2.625 (203 x 67)	Coarse / X-Coarse	2 sides/grits, Mat
W8FCNB	8 x 2.625 (203 x 67)	Fine / Coarse	2 sides/grits, Mat
W8EFNB	8 x 2.625 (203 x 67)	X-Fine / Fine	2 sides/grits, Mat
W8ECNB	8 x 2.625 (203 x 67)	X-Fine / Coarse	2 sides/grits, Mat
W8CX-WB	8 x 2.625 (203 x 67)	Coarse / X-Coarse	2 sides/grits, Base
W8FC-WB	8 x 2.625 (203 x 67)	Fine / Coarse	2 sides/grits, Base
W8EF-WB	8 x 2.625 (203 x 67)	X-Fine / Fine	2 sides/grits, Base
W8EC-WB	8 x 2.625 (203 x 67)	X-Fine / Coarse	2 sides/grits, Base
WM8CX	8 x 2.625 (203 x 67)	Coarse / X-Coarse	2 sides/grits, Continuous zone, Mat
WM8FC	8 x 2.625 (203 x 67)	Fine / Coarse	2 sides/grits, Continuous zone, Mat
WM8EF	8 x 2.625 (203 x 67)	X-Fine / Fine	2 sides/grits, Continuous zone, Mat
WM8FC-WB	8 x 2.625 (203 x 67)	Fine / Coarse	2 sides/grits, Continuous zone, Base
WM8EF-WB	8 x 2.625 (203 x 67)	X-Fine / Fine	2 sides/grits, Continuous zone, Base
W250CXNB	10 x 4 (250 x 100)	Coarse / X-Coarse	2 sides/grits, Mat
W250FCNB	10 x 4 (250 x 100)	Fine / Coarse	2 sides/grits, Mat
W250EFNB	10 x 4 (250 x 100)	X-Fine / Fine	2 sides/grits, Mat
W250ECNB	10 x 4 (250 x 100)	X-Fine / Coarse	2 sides/grits, Mat
W250CX-WB	10 x 4 (250 x 100)	Coarse / X-Coarse	2 sides/grits, Base
W250FC-WB	10 x 4 (250 x 100)	Fine / Coarse	2 sides/grits, Base
W250EF-WB	10 x 4 (250 x 100)	X-Fine / Fine	2 sides/grits, Base
W250EC-WB	10 x 4 (250 x 100)	X-Fine / Coarse	2 sides/grits, Base
W8EF-H-WB	8 x 2.625 (203 x 67)	X-Fine / Fine	HardCoat, 2 sides/grits, Base
<b>BENCH STONES PAGE 8-9</b>			
D11X	11.5 x 2.5 (292 x 64)	X-Coarse	Rubber feet
D11C	11.5 x 2.5 (292 x 64)	Coarse	Rubber feet
D11F	11.5 x 2.5 (292 x 64)	Fine	Rubber feet
D11E	11.5 x 2.5 (292 x 64)	X-Fine	Rubber feet
D10C	10 x 4 (254 x 102)	Coarse	Rubber feet
D10F	10 x 4 (254 x 102)	Fine	Rubber feet
D10E	10 x 4 (254 x 102)	X-Fine	Rubber feet
D8XX	8 x 3 (203 x 76)	XX-Coarse	Rubber feet
D8X	8 x 3 (203 x 76)	X-Coarse	Rubber feet
D8C	8 x 3 (203 x 76)	Coarse	Rubber feet
D8F	8 x 3 (203 x 76)	Fine	Rubber feet

Model Number	Sharpener Size inches (millimeters)	Diamond Grit X=extra, XX=extra-extra	Special Features
D8E	8 x 3 (203 x 76)	X-Fine	Rubber feet
D8EE	8 x 3 (203 x 76)	XX-Fine	Rubber feet
D6X	6 x 2 (152 x 51)	X-Coarse	Rubber feet
D6C	6 x 2 (152 x 51)	Coarse	Rubber feet
D6F	6 x 2 (152 x 51)	Fine	Rubber feet
D6E	6 x 2 (152 x 51)	X-Fine	Rubber feet
D6CX	6 x 2 (152 x 51)	Coarse / X-Coarse	2 sides/grits
D6FC	6 x 2 (152 x 51)	Fine / Coarse	2 sides/grits
D6EF	6 x 2 (152 x 51)	X-Fine / Fine	2 sides/grits
D6FX	6 x 2 (152 x 51)	Fine / X-Coarse	2 sides/grits
D12CX-WB	12 x 3 (305 x 76)	Coarse / X-Coarse	2 sides/grits, MagnaBase™
D12EF-WB	12 x 3 (305 x 76)	X-Fine / Fine	2 sides/grits, MagnaBase™
WAV-F	10 x 2.36 (254 x 60)	Fine	Curved surface, Mat
WAV-E	10 x 2.36 (254 x 60)	X-Fine	Curved surface, Mat
DCSFH	4 (102)	Fine	0.125 to 0.375" diameter cone
DCMF	6 (152)	Fine	0.375 to 0.75" dia. half-round cone
DCLF	8 (203)	Fine	0.75 to 1.25" dia. half-round cone
DCKF	(see above)	Fine	3 cones, Wood box
TCKIT-F	(see above)	Fine	3 cones, one D3, one pouch
DP6	—	6 Micron	2 gram syringe
DP3	—	3 Micron	2 gram syringe
DP1	—	1 Micron	2 gram syringe
DPK	—	1, 3, and 6 Micron	3 grit set, 2 gram syringes
DSPRAY.5	—	0.5 Micron	1.69 fluid oz (50 ml)
B8250	—	—	12" x 5" base, Rubber feet
B8250-MBA	—	—	12" x 5" magnetic base, Rubber feet
SR009	—	—	10" x 4" mat, Non-skid coating
SR009-8	—	—	2.625" x 8" mat, Non-skid coating

### PORTABLE SHARPENERS PAGE 10-11

Model Number	Sharpener Size inches (millimeters)	Diamond Grit X=extra, XX=extra-extra	Special Features
FWCX	4.33 x 0.875 (110 x 22)	Coarse / X-Coarse	2 sides/grits
FWFC	4.33 x 0.875 (110 x 22)	Fine / Coarse	2 sides/grits
FWEF	4.33 x 0.875 (110 x 22)	X-Fine / Fine	2 sides/grits
FWEE	4.33 x 0.875 (110 x 22)	X-Fine / XX-Fine	2 sides/grits
FWX	4.33 x 0.875 (110 x 22)	X-Coarse	
FWC	4.33 x 0.875 (110 x 22)	Coarse	
FWF	4.33 x 0.875 (110 x 22)	Fine	
FWE	4.33 x 0.875 (110 x 22)	X-Fine	
20000	5.75 x 1.58 (146 x 40)	Fine	
20004	6.25 x 2.34 (159 x 59)	Fine	
FSKC	4.44 (113)	Coarse	0.25 to 0.0625" diameter taper
FSKF	4.44 (113)	Fine	0.25 to 0.0625" diameter taper
FSKE	4.44 (113)	X-Fine	0.25 to 0.0625" diameter taper
FFC	4.44 (113)	Coarse	0.75 to 0.25" tapered file
FFF	4.44 (113)	Fine	0.75 to 0.25" tapered file
FCS7C	4.44 (113)	Coarse	7/32" diameter rod
FCS6C	4.44 (113)	Coarse	6/32" diameter rod
FCS5C	4.44 (113)	Coarse	5/32" diameter rod
FFHWC	4.33 x 0.875 (110 x 22)	Coarse	Hook sharpening groove
FFHWF	4.33 x 0.875 (110 x 22)	Fine	Hook sharpening groove
FWMEF-H	4.33 x 0.875 (110 x 22)	X-Fine / Fine	HardCoat, 2 sides/grits

# INDEX



Model Number	Sharpener Size inches (millimeters)	Diamond Grit X=extra, XX=extra-extra	Special Features
<b>POCKET SHARPENERS PAGE 12-13</b>			
F70X	2.76 x 0.98 (70 x 25)	X-Coarse	Swivel key ring
F70C	2.76 x 0.98 (70 x 25)	Coarse	Swivel key ring
F70F	2.76 x 0.98 (70 x 25)	Fine	Swivel key ring
F70E	2.76 x 0.98 (70 x 25)	X-Fine	Swivel key ring
FF70C	2.76 x 0.98 (70 x 25)	Coarse	Hook sharpening groove
FF70F	2.76 x 0.98 (70 x 25)	Fine	Hook sharpening groove
W7C	2.76 x 0.98 (70 x 25)	Coarse	
W7F	2.76 x 0.98 (70 x 25)	Fine	
W7E	2.76 x 0.98 (70 x 25)	X-Fine	
W7EFC	2.76 x 0.98 (70 x 25)	X-Fine, Fine, Coarse	3 grit set
W4X	4.33 x 0.875 (110 x 22)	X-Coarse	Leather pouch
W4C	4.33 x 0.875 (110 x 22)	Coarse	Leather pouch
W4F	4.33 x 0.875 (110 x 22)	Fine	Leather pouch
W4E	4.33 x 0.875 (110 x 22)	X-Fine	Leather pouch
W4EE	4.33 x 0.875 (110 x 22)	XX-Fine	Leather pouch
W4K	4.33 x 0.875 (110 x 22)	X-Coarse, Coarse, Fine, X-Fine	4 grit set, Fabric pouch
WMC	4.33 x 0.875 (110 x 22)	Coarse	Continuous zone, Leather pouch
WMF	4.33 x 0.875 (110 x 22)	Fine	Continuous zone, Leather pouch
WME	4.33 x 0.875 (110 x 22)	X-Fine	Continuous zone, Leather pouch
20005	4.8 x 1.17 (122 x 30)	Fine	Fire starter and carabiner
20006	5.5 x 1.27 (140 x 32)	Fine	Multi-tools
WS4XX	4.33 x 0.875 (110 x 22)	XX-Coarse	Winter sport model
WS4X	4.33 x 0.875 (110 x 22)	X-Coarse	Winter sport model
WS4C	4.33 x 0.875 (110 x 22)	Coarse	Winter sport model
WS4F	4.33 x 0.875 (110 x 22)	Fine	Winter sport model
WS7XX	2.76 x 0.98 (70 x 25)	XX-Coarse	Winter sport model
WS7X	2.76 x 0.98 (70 x 25)	X-Coarse	Winter sport model
WS7C	2.76 x 0.98 (70 x 25)	Coarse	Winter sport model
WS7F	2.76 x 0.98 (70 x 25)	Fine	Winter sport model
WS7K	2.76 x 0.98 (70 x 25)	Fine, Coarse, X-Coarse	3 grit set, Ski model
WS7K2	2.76 x 0.98 (70 x 25)	XX-Coarse, X-Coarse, Coarse	3 grit set, Ski model
D4C	4 x 0.875 (102 x 22)	Coarse	
D4F	4 x 0.875 (102 x 22)	Fine	
D4E	4 x 0.875 (102 x 22)	X-Fine	
D3C	3.25 x 2 (83 x 51)	Coarse	Vinyl sleeve
D3F	3.25 x 2 (83 x 51)	Fine	Vinyl sleeve
D3E	3.25 x 2 (83 x 51)	X-Fine	Vinyl sleeve
D3EFC	2.5 x 0.75 (63.5 x 19)	X-Fine, Fine, Coarse	3 grit set, Vinyl sleeve
D2C	2.5 x 0.75 (63.5 x 19)	Coarse	
D2F	2.5 x 0.75 (63.5 x 19)	Fine	
D2E	2.5 x 0.75 (63.5 x 19)	X-Fine	
D2K	2.5 x 0.75 (63.5 x 19)	X-Fine, Fine, Coarse	3 grit set
OD2C	2.5 x 0.75 (63.5 x 19)	Coarse	Offset handle
OD2F	2.5 x 0.75 (63.5 x 19)	Fine	Offset handle
OD2E	2.5 x 0.75 (63.5 x 19)	X-Fine	Offset handle
OD2K	2.5 x 0.75 (63.5 x 19)	X-Fine, Fine, Coarse	3 grit set, Offset handle

Model Number	Sharpener Size inches (millimeters)	Diamond Grit X=extra, XX=extra-extra	Special Features
<b>GUIDED SHARPENERS PAGE 14-15</b>			
MAGKIT-4	4.33 x 0.875 (110 x 22)	XX-Fine / X-Fine, Fine / Coarse	4 grit set (2 double-sided), Case
MAGKIT-EF	4.33 x 0.875 (110 x 22)	X-Fine / Fine	2 grit set (1 double-sided model)
MGUIDE	—	—	No-scratch clamp, Angle guide
A-PROKIT	4.33 x 0.875 (110 x 22)	X-Fine, Fine, Coarse	3 grit set, Serrated sharpener, Case
ADELUXE	4.33 x 0.875 (110 x 22)	X-Fine, Fine, Coarse	3 grit set, Serrated sharpener, Pouch
AKEFCX	4.33 x 0.875 (110 x 22)	X-Fine, Fine, Coarse, X-Coarse	4 grit set, Pouch
AKEFC	4.33 x 0.875 (110 x 22)	X-Fine, Fine, Coarse	3 grit set, Pouch
AKFC	4.33 x 0.875 (110 x 22)	Fine, Coarse	2 grit set, Pouch
AHF	4.33 x 0.875 (110 x 22)	Fine	Collapsible stone holder
ABG	—	—	No-scratch clamp, 7 angles
A4XX	4.33 x 0.875 (110 x 22)	XX-Coarse	
A4X	4.33 x 0.875 (110 x 22)	X-Coarse	
A4C	4.33 x 0.875 (110 x 22)	Coarse	
A4F	4.33 x 0.875 (110 x 22)	Fine	
A4E	4.33 x 0.875 (110 x 22)	X-Fine	
A4EE	4.33 x 0.875 (110 x 22)	XX-Fine	
<b>COUNTERTOP SHARPENERS PAGE 16</b>			
20003	4.54 x 3.61 (115 x 92)	Fine	Sharpens Both Edges Simultaneously
20001	4.62 x 4.45 (117 x 113)	Fine	Battery powered
<b>SHARPENING STEELS PAGE 17</b>			
DS4F	14 x 0.375 (356 x 10)	Fine	Safety guard, Hang ring
DS2F	12 x 0.375 (305 x 10)	Fine	Safety guard, Hang ring
DS2E	12 x 0.375 (305 x 10)	X-Fine	Safety guard, Hang ring
DS0F	10 x 0.375 (254 x 10)	Fine	Safety guard, Hang ring
CS2	12 x 0.5 (305 x 13)	n/a**	Ceramic, Safety guard, Hang ring
C00	Length: 4.25 (108)	Coarse	Half-round multi-purpose rod
<b>LAPPING PAGE 18</b>			
DIAFLAT	10 x 4 (254 x 102)	120 Micron	hand certified flat to < ±0.0005"
DIAFLAT-95	10 x 4 (254 x 102)	95 Micron	hand certified flat to < ±0.0005"

DMT®, Dia-Sharp®, DuoSharp®, Diafold®, Diamond-Vee®, Mini-Sharp®, Magna-Guide®, Mini-Hone®, Crystal Saver® and Dia-Flat® are registered trademarks of Acme United Corporation

The Leader in Diamond Sharpening™, Whetstone™, Plus™, MagnaBase™, HC™, Diamond Wave™, Slydr-Sharp™, SURVIVAL-Sharp™, EDC-Sharp™, Aligner™, Simple-Sharp™, Sonic-Sharp™ and Diamond Steel™ are trademarks of Acme United Corporation.

\* All sharpener measurements exclude dimensions of handle

\*\* Ceramic steels carry a 7 micron (2200 mesh) abrasive that contains no diamond grit.