

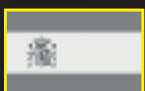

FAMAG®

... a cut above



DELTA-F

We produce quality tools for a better drilling since 1865!



Firma Friedr. Aug. Mühlhoff AG

REMSCHIED-RATH.

M 1:100.

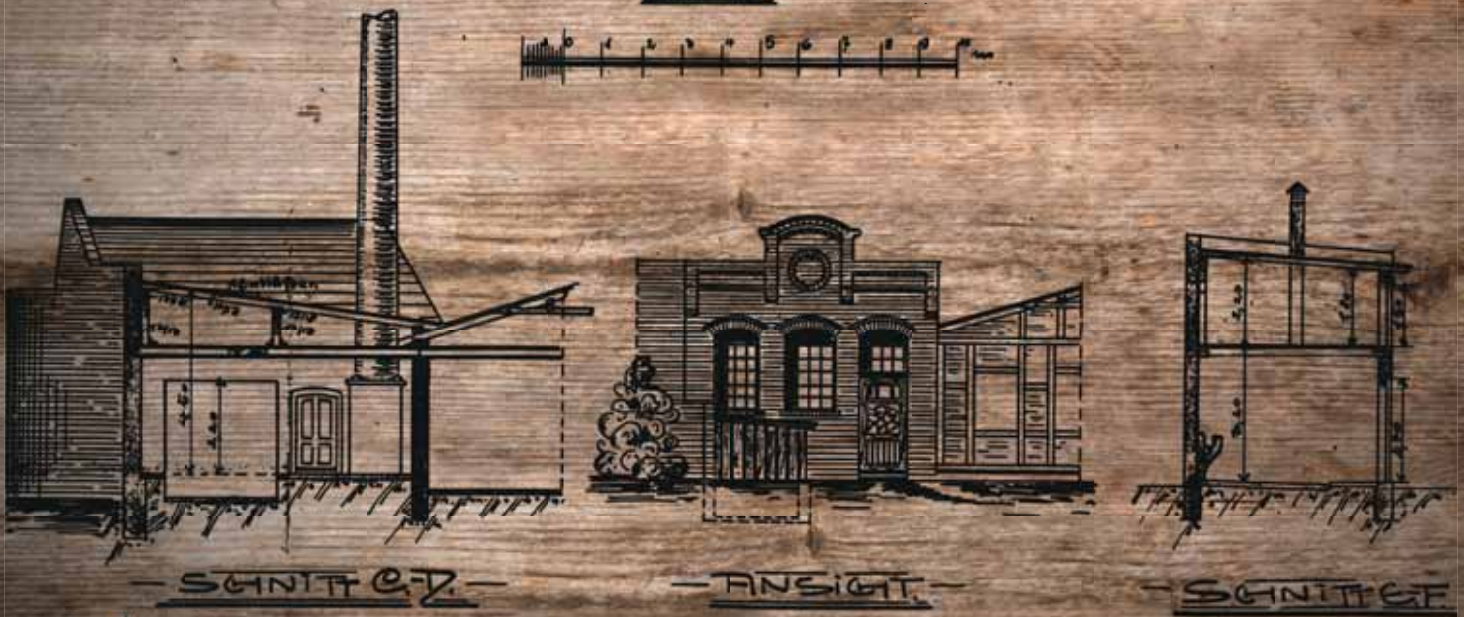

Make a statement: Become a DELTA-F!

Today, we are pleased to present the new FAMAG catalogue, which bears a title hat reflects our philosophy: DELTA-F. This is our mark on the ever-changing modern world.



We all know the letter 'Delta' from the Greek alphabet. In mathematics and technology it means amongst other things, a small difference between operand and measurand. Figuratively speaking it refers to the difference between two things which at first sight look

the same, but can be very different when considered in detail. Does that sound familiar to you? Could we be talking about tools?

It could also be said that 'Delta' is a principal element for a mark of superior quality. Superior to what, though? Tools that stand out in the market for their superior quality. We want to define ourselves and the quality of our tools through the creation of our own Delta standard. In other words DELTA-F, or DELTA FAMAG. But what does this mean in practice?

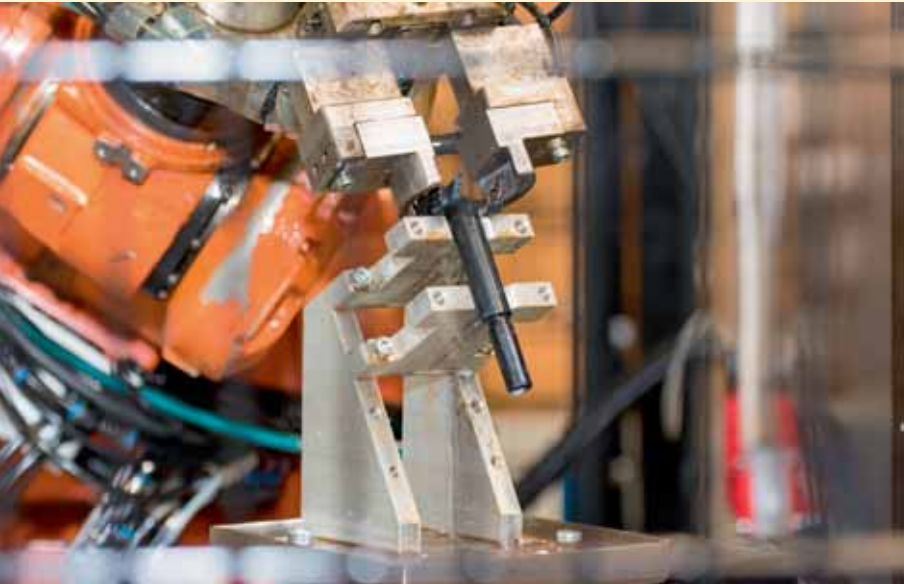

Let's take our customer service as an example: If you call us, you can be sure that you will talk to a human being; someone who has learned his trade, is competent and who will help you. We guarantee to inform you of the cost of an item, its availability and when you can expect to receive it. If it has already been dispatched we will tell you exactly where it is and when you can expect it to arrive. But more than this, for us, 'service' also means being able to advise you on the most suitable FAMAG product to get the

best drilling results, no matter the wood. Finally, for us, 'service' means having sufficient stock quantities of all the products in our catalogue. We want you to be able to place your order today, and receive your FAMAG products tomorrow. Please call us, we will listen to you and are open to your suggestions.

But that's not all. You will also find the difference in our products in form of further developments of the traditional tools and the hereby resulting unique selling points. Sometimes these improvements are so subtle, that they are barely discernible with the naked eye. More than 150 years of experience and an ultra-modern machinery enable us to manufacture such products in daily series.



At latest in the application you will discover that this small DELTA-F simply gives pleasure. A small sign in many ways. But might it also be a sign that sets a new standard? The DELTA-F range will impress you with their superior cutting properties, their ease of use, their incredible performance and their durability.



As you browse through our new catalogue, keep an eye out for the products in the DELTA-F range. It is very easy to identify them, as they are all marked with the new logo. As well as that you will also see a QR code. Access the code to discover all the fine details and special qualities of these wonderful tools!

Do you share our view that our products are quite simply in a class of their own? If you agree that the time has come to take a different and better approach, then take a stand! Use only quality tools; crafted with care in Germany! Join us as part of DELTA-F! With DELTA-F we put a small sign on the ever-changing modern world – it's a small symbol that represents a community of values – the world of DELTA-F.



Email us your address to DELTA-F@famag.com and we will send you our complimentary DELTA-F pin.

We wish you every success with your work and hope you greatly enjoy using the FAMAG tools "Made in Germany".

Sincerely Yours,

Thomas Pomp & Ralf Hunke

Drills and Countersinks for Wood **5**

Hole Saws **69**

Router Bits **79**

Twist Drills and Countersinks for Metal **105**

Hand Tools **121**

Information **125**

Article index **140**

NEW

Looking for the difference?

Looking for real highlights in this catalogue? Products, which are incomparable and have practice-oriented unique selling points? Welcome as a friend of the DELTA-F products. Please take some time and have a closer look at the new catalogue. For the first time all DELTA-F products are marked with a QR code in this new edition. Following the code you will receive interesting details about all these articles. We tell you something about the history and practice of today. The characteristics of the tools are described in detail and we specify the perfect application. We show the unique selling points and define the product-



parameters as well as details of the packaging. For the bestsellers of each product group we point out the recommended speed rotation. Finally you receive information about the available sets of each DELTA-F product and if there is any accessory available. Perhaps there is an alternative tool that suits you better? We will find it for you. Now we wish you a lot of pleasure with the new DELTA-F's. For any question you may have please do not hesitate to contact us by phone or e-mail - we are at your disposal.

Information blocks

Abbreviations

Ø	outer diameter
∅	inner diameter
SØ	shank diameter
L	length of shaft/ shank length
OAL	overall length
MC/HS	main cutters
EL	Effective length
SPL	Spiral length
W	weight
T	teeth
R	radius
∠	degrees
max.rpm	maximum acceptable rpm
L1	length of first step (step drill bit)
L2	length of second step (step drill bit)
D1	core diameter
Lead/1"	no. of threads
PU	packing unit



Subtle distinction



Description
of the tool design



Tool material



Recommended rpm and specific
example for the most common diameters
in the corresponding field of application



Description of application



Practical advice and
specialty of the tool



Packaging unit and information on
individual packaging

Quality classification

- **quality level Hobby:**
reasonable quality tools for the
non-professional segment
- **quality level Classic:**
for the quality-conscious user
- **quality level Profi:**
professional tools for the craftsman
with high demanding requirements
on tool and application
- **quality level Excellent:**
wear-resistant tools of the highest
quality level, even for extreme
conditions of use

Drills and Countersinks for Wood

5

Bormax® 2.0, Forstner Bit	6
Bormax® 2.0 Prima (Pilot Guided)	9
Bormax® 2.0 Prima, Long Version (Special Counterbore)	10
TCT Bormax³ Prima (Pilot Guided)	12
TCT-Bormax³, Forstner Bit	14
TCT-Cylinder Boring Bit	15
Forstner Bit, Classic	17
Cylinder Boring Bit	18
Depth Stop supported by Ball Bearing	19
Disc + Plug Cutter	20
Extension	22
Spiral Slot Milling Cutter	24
Auger Bit, Lewis Pattern	27
Countersink for Auger Bits 180°	30
Special Auger Bit for Joinery Machines	31
Auger Bit with Morse Cone Shank No. 2	32
Auger Bit for Hard Wood	34
Special Adapter	35
Formwork Drill Bit, Cylindrical Shank	37
Depth Guide & Drill Rigs	41
Drill Rig for stairs building, pivoting	44
Drill Bit for Construction of Stairs	45
Brad Point Drill	46
Right-Angle-Driver 90fix	55
Brad Point Drill with Bit Shank	56
Step Drill Bit, HSS	58
Countersink, with Pointed Angle 90°, HSS	60
Countersink	62
Drill Bit - Countersink Set	63
Machine Expansive Bit	67
Flat Centre Bit	68

1622

Profi

Bormax® 2.0, Forstner Bit

FAMAG®
...für Besserbohrer®



Art.- No.	O-Ø [mm]	Stem Ø [mm]	SØ [mm]	OAL [mm]	Effective L. [mm]	€
1622.008	8	6,5	8	90	57	21,80
1622.009	9	7,5	8	90	57	21,80
1622.010	10	8	8	90	57	21,80
1622.011	11	8	8	90	57	21,80
1622.012	12	8	8	90	57	21,80
1622.013	13	8	8	90	57	21,80
1622.014	14	8	8	90	57	22,50
1622.015	15	8	8	90	57	22,00
1622.016	16	8	8	90	57	22,00
1622.017	17	8	8	90	57	23,95
1622.018	18	8	8	90	57	23,95
1622.019	19	8	8	90	57	28,75
1622.020	20	8	8	90	57	23,95
1622.021	21	8	8	90	57	28,75
1622.022	22	10	10	90	57	25,90
1622.023	23	10	10	90	57	26,70
1622.024	24	10	10	90	57	26,70
1622.025	25	10	10	90	57	27,65
1622.026	26	10	10	90	57	27,65
1622.027	27	10	10	90	57	35,65
1622.028	28	12	10	90	57	32,00
1622.029	29	12	10	90	57	38,80
1622.030	30	12	10	90	57	32,00
1622.032	32	12	10	90	57	32,00
1622.033	33	12	10	90	57	38,80
1622.034	34	12	10	90	57	38,80
1622.035	35	12	10	90	57	38,80
1622.036	36	14	10	90	57	45,10
1622.038	38	14	10	90	57	45,10
1622.040	40	14	10	90	57	45,10
1622.042	42	16	10	90	57	59,05
1622.043	43	16	10	90	57	59,05
1622.044	44	16	10	90	57	59,05
1622.045	45	16	10	90	57	59,05
1622.046	46	16	10	90	57	65,50
1622.048	48	16	10	90	57	65,50
1622.049	49	18	10	90	57	96,00
1622.050	50	18	10	90	57	65,50
1622.054	54	18	10	90	57	105,55
1622.055	55	20	13	90	57	96,00
1622.058	58	20	13	90	57	98,45
1622.060	60	20	13	90	57	99,15

Sets

Art.- No.	Description	€
1622.505	5 pcs. Set in wooden case Ø 15, 20, 25, 30, 35 mm	129,75
1622.606	6 pcs. Set in wooden case Ø 15, 20, 25, 30, 35, 40 mm	170,30
1622.570	7 pcs. Set in wooden case Ø 15, 20, 25, 30, 35, 40, 50 mm	229,20
1622.508	8 pcs. Set in wooden case Ø 15, 20, 25, 30, 35, 40, 45, 50 mm	282,25
1622.515	15 pcs. Set in wooden case Ø 10, 12, 15, 16, 18, 20, 22, 25, 26, 28, 30, 35, 40, 45, 50 mm	439,50
1622.504	4 pcs. Set in wooden case Ø 35, 40, 45, 50 mm	187,50
1622.530	3 pcs. Set in wooden case Ø 40, 50, 60 mm	188,70

	<p>Bormax 2.0! Centre point with cutting character. Two in reverse order staggered, grooved main cutting edges (from Ø 11 mm), a circumferential cutting edge with longitudinal grooves - both effecting that a clear less feed force is necessary. Also they minimize the friction and the growth of heat. Hexagonal shank for a better power transfer</p>		<p>Rapid drilling in soft wood, European hard wood, chipboard, MDF etc. Rapid chipping of solid wood and chipboards. Clearly less effort is needed and boring is more rapid than with the usual Forstner bit</p>
	<p>Alloyed tool steel</p>		<p>Top for freehand drilling and stationary use. The low heat development offers an incredibly long service life with highest drilling quality. In combination with extension shanks of product line 1639 perfectly suitable for drilling deep holes</p>
	<p>900 - 3200 rpm. e.g. Ø 35 mm 1500 rpm in glue lam (glue laminated timber). Further details in the speed diagram</p>		<p>Packing unit = 1, Blister pack</p>

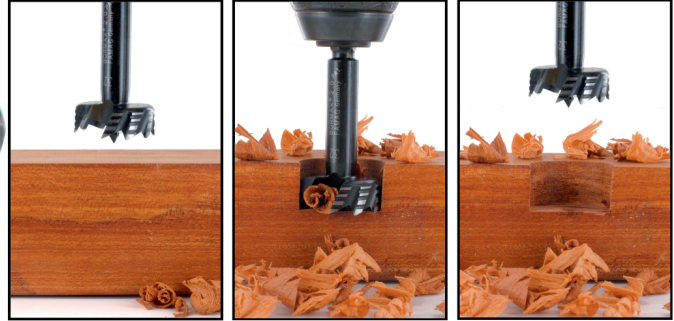

Art.- No.	O-Ø [mm]	AØ [Inch]	Stem Ø [mm]	SØ [mm]	OAL [mm]	Effective L. [mm]	€
1622.214	7,94	5/16	6,5	8	90	57	24,25
1622.215	9,53	3/8	8	8	90	57	24,25
1622.217	12,7	1/2	8	8	90	57	24,25
1622.219	15,88	5/8	8	8	90	57	24,25
1622.220	17,46	11/16	8	8	90	57	26,30
1622.221	19,05	3/4	8	8	90	57	26,30
1622.222	20,64	13/16	8	8	90	57	31,60
1622.223	22,23	7/8	10	10	90	57	28,50
1622.224	23,81	15/16	10	10	90	57	29,30
1622.225	25,4	1	10	10	90	57	30,50
1622.226	26,99	1 1/16	10	10	90	57	35,65
1622.227	28,58	1 1/8	12	10	90	57	42,60
1622.228	30,16	1 3/16	12	10	90	57	35,20
1622.229	31,75	1 1/4	12	10	90	57	35,20
1622.230	33,34	1 5/16	12	10	90	57	42,60
1622.231	34,93	1 3/8	12	10	90	57	38,80
1622.233	38,05	1 1/2	14	10	90	57	49,65
1622.235	41,28	1 5/8	14	10	90	57	64,95
1622.237	44,45	1 3/4	16	10	90	57	64,95
1622.239	47,63	1 7/8	16	10	90	57	72,05
1622.241	50,8	2	18	10	90	57	72,05
1622.243	53,98	2 1/8	18	10	90	57	105,55
1622.245	57,15	2 1/4	20	13	90	57	109,05

Sets

Art.- No.	Description	€
1622.605	5 pcs. Set in wooden case Ø 5/8, 3/4, 1, 1 1/8, 1 3/8 INCH	161,15
1622.607	7 pcs. Set in wooden case Ø 1/4, 3/8, 1/2, 5/8, 3/4, 7/8, 1 INCH	161,15
1622.616	16 pcs. Set in wooden case Ø 1/4, 3/8, 1/2, 5/8, 3/4, 7/8, 1, 1 1/8, 1 1/4, 1 3/8, 1 7/8, 2, 2 1/8 INCH	668,90

	Bormax 2.0! Centre point with cutting character. Two in reverse order staggered, grooved main cutting edges (from Ø 11 mm), a circumferential cutting edge with longitudinal grooves - both effecting that a clear less feed force is necessary. Also they minimize the friction and the growth of heat. Hexagonal shank for a better power transfer		Rapid drilling in soft wood, European hard wood, chipboard, MDF etc. Rapid chipping of solid wood and chipboards. Clearly less effort is needed and boring is more rapid than with the usual Forstner bit
	Alloyed tool steel		Top for freehand drilling and stationary use. The low heat development offers an incredibly long service life with highest drilling quality
	900 - 3200 rpm. e.g. Ø 1 inch 2200 rpm in glue lam (glue laminated timber). Further details in the speed diagram		Packing unit = 1, Blister pack

1623







Profi

Bormax® 2.0, Forstner Bit, Long Version

FAMAG®
...für Besserbohrer®

Art.- No.	Description	O-Ø [mm]	AØ [Inch]	Stem Ø [mm]	SØ [mm]	OAL [mm]	Effective L. [mm]	€
1623.010		10		8	13	120	70	29,70
1623.012		12		8	13	120	70	29,70
1623.013	End of Series	13		8	13	125	75	29,70
1623.014		14		8	13	125	75	29,70
1623.015		15		8	13	125	75	27,65
1623.016		16		8	13	125	75	30,15
1623.018		18		8	13	130	80	32,30
1623.019		19		8	13	130	80	34,10
1623.020		20		8	13	130	80	32,30
1623.022		22		13	13	130	80	32,75
1623.024		24		13	13	135	85	33,80
1623.025		25		13	13	135	85	34,10
1623.225		25,40	1"	13	13	135	85	38,85
1623.026		26		13	13	135	85	37,35
1623.226		26,99	1 1/16	13	13	135	85	42,30
1623.027	End of Series	27		13	13	135	85	42,30
1623.028		28		13	13	135	85	38,85
1623.030		30		13	13	140	90	39,60
1623.229		31,75	1 1/4"	14	13	140	90	45,10
1623.032		32		14	13	140	90	42,30
1623.034		34		14	13	140	90	50,80
1623.035		35		14	13	145	95	45,80
1623.036		36		14	13	145	95	50,10
1623.038		38		16	13	145	95	54,70
1623.233		38,10	1 1/2"	16	13	145	95	62,25
1623.040		40		16	13	145	95	54,70

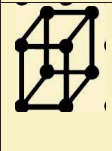
For bigger diameters we recommend product line 1614 on page 10

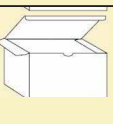
	Bormax 2.0! Centre point with cutting character. Two in reverse order staggered, grooved main cutting edges, a circumferential cutting edge with longitudinal grooves - both effecting that a clear less feed force is necessary. Also they minimize the friction and the growth of heat. Hexagonal shank for a better power transfer		Rapid drilling in soft wood, European hard wood, chipboard, MDF etc. Rapid chipping of solid wood and chipboards. Clearly less effort is needed and boring is faster than with the usual Forstner bit
	Alloyed tool steel		Top for freehand drilling and stationary use. The low heat development offers an incredibly long service life with highest drilling quality. In combination with extension shanks product line 1639 perfectly suitable for drilling deep holes. For bigger diameters we recommend product line 1614 Bormax® 2.0 WS prima, long version
	900 - 3200 rpm. e.g. Ø 30 mm 1750 rpm in soft wood. Further details in the speed diagram		Packing unit = 1, yellow cardboard tube

Technical changes or mistakes reserved! All prices are recommended retail prices additionally value added tax.







Art.- No.	O-Ø [mm]	Stem Ø [mm]	SØ [mm]	OAL [mm]	Effective L. [mm]	HS	€
1624.015	15	10	10	90	57	1	30,95
1624.016	16	10	10	90	57	1	30,95
1624.162	16,2	10	10	90	57	1	33,00
1624.018	18	10	10	90	57	1	33,00
1624.020	20	10	10	90	57	1	33,00
1624.022	22	10	10	90	57	2	35,10
1624.025	25	10	10	90	57	2	36,75
1624.030	30	12	10	90	57	2	41,05
1624.035	35	12	10	90	57	2	47,90
1624.040	40	14	10	90	57	2	54,25
1624.045	45	16	10	90	57	2	69,15
1624.050	50	18	10	90	57	2	74,60

Accessory

Art.- No.	Description	O-Ø [mm]	SØ [mm]	OAL [mm]	Effective L. [mm]	PU [pcs]	€
1624.004	pre-drill bit	4	4	45	30	1	3,75
1624.104	pre-drill bit (PU 4)	4	4	45	30	4	13,40
1624.005	Centre point	4	4	22	6	1	3,05
1624.105	Centre point (PU 4)	4	4	22	6	4	11,00

Sets

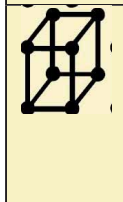
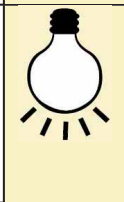
Art.- No.	Description	€
1624.505	5 pcs. Set in wooden case Ø 15, 20, 25, 30, 35 mm	170,60
1624.507	5 pcs. Set in wooden case Ø 16, 18, 20, 22, 25 mm	151,85
1624.506	6 pcs. Set in wooden case Ø 15, 20, 25, 30, 35 mm incl. extension 125 mm (1639.001)	191,35
1624.606	6 pcs. Set in wooden case Ø 15, 20, 25, 30, 35, 40 mm	219,40
1624.570	7 pcs. Set in wooden case Ø 15, 20, 25, 30, 35, 40, 50 mm	286,55
1624.508	8 pcs. Set in wooden case Ø 15, 20, 25, 30, 35, 40, 45, 50 mm	348,75
1624.509	9 pcs. Set in wooden case Ø 15, 20, 25, 30, 35, 40, 45, 50 mm incl. extension 250 mm (1639.002)	373,45
1624.504	4 pcs. Set in wooden case Ø 35, 40, 45, 50 mm	221,25

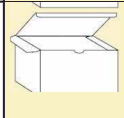
	<p>Bormax 2.0 prima with exchangeable centre point and pre-drill bit. Two in reverse order staggered, grooved main cutting edges, a circumferential cutting edge with longitudinal grooves - both effecting that a clear less feed force is necessary. Also they minimize the friction and the growth of heat</p>		<p>The pilot-drill bit is ideal for drilling at an angle which is not 90° in workpieces surface, which occurs for example in the construction of staircase. Can be used with the centre point as traditional Bormax</p>
	<p>Alloyed tool steel, pre-drill bit HSS-G</p>		<p>Clean drilling at many angles into soft wood, European hard wood, and MDF panels. Very good alternative to the expensive drill bit for construction of stairs product line 1575. In combination with extension shanks product line 1639 perfectly suitable for drilling deep holes. For harder materials like solid wood or plastic coated boards we recommend our new product line 1664 from page 13</p>
	<p>1500 - 3000 rpm. e.g. Ø 20 mm 2400 rpm in soft wood. Further details in the speed diagram</p>		<p>Packing unit = 1, Blister pack</p>

1614

 Profi

Bormax® 2.0 Prima, Long Version (Special Counterbore)
FAMAG®
...für Besserbohrer®







Art.- No.	O-Ø [mm]	AØ [Inch]	Stem Ø [mm]	SØ [mm]	lØ [mm]	OAL [mm]	Effective L. [mm]	€
1614.020	20		13	13	8	140	90	78,05
1614.025	25		13	13	8	140	90	81,20
1614.030	30		14	13	8	140	90	89,85
1614.032	32		14	13	8	140	90	93,90
1614.035	35		16	13	8	145	95	93,90
1614.040	40		20	13	8	145	95	102,25
1614.237	44,45	1 3/4"	20	13	10	150	100	108,45
1614.045	45		20	13	10	150	100	108,45
1614.050	50		20	13	10	150	100	113,75
1614.241	50,80	2"	20	13	10	150	100	113,75
1614.243	53,98	2 1/8"	20	13	10	150	100	123,85
1614.054	54		20	13	10	150	100	145,05
1614.055	55		20	13	10	150	100	113,75
1614.245	57,15	2 1/4"	20	13	10	150	100	123,85
1614.058	58		20	13	10	150	100	123,85
1614.060	60		20	13	10	150	100	123,85
1614.247	60,33	2 3/8"	20	13	10	155	105	144,50
1614.249	63,50	2 1/2"	20	13	10	155	105	154,85
1614.065	65		20	13	10	155	105	144,50
1614.251	66,68	2 5/8"	20	13	10	155	105	154,85
1614.068	68		20	13	10	155	105	154,85
1614.253	69,85	2 3/4"	20	13	10	155	105	154,85
1614.070	70		20	13	10	155	105	154,85
1614.255	73,03	2 7/8"	20	13	10	155	105	185,80
1614.075	75		20	13	10	155	105	185,80
1614.257	76,20	3"	20	13	10	155	105	185,80
1614.080	80		20	13	10	155	105	185,80
1614.085	85		20	13	10	160	110	232,30
1614.261	88,90	3 1/2"	20	16	10	160	110	232,30
1614.090	90		20	16	10	160	110	232,30
1614.095	95		24	16	10	160	110	289,05
1614.100	100		24	16	10	160	110	289,05
1614.265	101,60	4"	24	16	10	160	110	289,05
1614.110	110		25	16	10	160	110	335,55
1614.120	120		25	16	10	160	110	335,55

Accessory

Art.- No.	Description	€
1619.208	HSS centre drill bit with shank-Ø 8 mm	17,40
1619.210	HSS centre drill bit with shank-Ø 10 mm	17,40
1614.208	HSS pre-drill bit Ø 8 mm for Ø 20 - 40 mm	17,40
1614.210	HSS pre-drill bit Ø 10 mm for Ø 44,45 - 120 mm	17,40

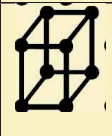
Sets

Art.- No.	Description	€
1614.509	Set of 9 pcs with depth stop in wooden case, 1614 Ø 50, 60, 70 mm. 1619 Ø 14, 18, 22 mm and MK2 fix adapter	452,55
1614.510	Combination set of 10 pcs: 1614 Ø 40, 50, 60 mm and auger bit 1410.3 incl. 1619 Ø 12, 14, 18 mm and extension shank 250 mm	417,70
1614.511	Combination set of 10 pcs: 1614 Ø 40, 50, 60 mm and auger bit 1410.3 incl. 1619 Ø 12, 16, 20 mm and extension shank 250 mm	425,20

	Bormax® 2.0 prima with exchangeable pre-drill bit, centre drill bit or guiding pin. Much less feed force needed as well as minimized friction and therefore less heat generation. Reasons: The two main cutting edges are grooved shifted, as well as the toothed linear grooved pre-cutters. A matching centre drill bit and an allen wrench are included in the delivery. Hexagonal shank for a better power transfer		Perfect fit for slanting drills with our pre-drill bit or guiding pins 1619. Clean drilling in soft wood, European hard wood, chipboard and MDF
	Alloyed tool steel		We recommend our Bormax® 2.0 WS prima (pilot guided) with matching extension for smaller diameters (1624 & 1639)
	300 - 800 rpm, for example Ø 60 mm 500 rpm in laminated timber. Further details in the speed diagram		packing unit = 1, yellow cardboard tube (Ø 100 mm max.) > 100 mm in carton

Guiding pin for Bormax prima long Ø 20 - 40 mm

Art.- No.	O-Ø [mm]	SØ [mm]	OAL [mm]	Effective L. [mm]	€
1619.008	8	8	75	50	17,40
1619.110	10	8	75	50	17,40
1619.112	12	8	75	50	18,95
1619.113	13	8	75	50	19,15
1619.114	14	8	75	50	19,15
1619.116	16	8	75	50	20,30
1619.118	18	8	75	50	21,25
1619.120	20	8	75	50	22,15
1619.122	22	8	75	50	25,95



Guiding pin for Bormax prima long from Ø 44, 45 mm

Art.- No.	O-Ø [mm]	SØ [mm]	OAL [mm]	Effective L. [mm]	€
1619.010	10	10	75	50	17,40
1619.012	12	10	75	50	18,95
1619.013	13	10	75	50	19,15
1619.014	14	10	75	50	19,15
1619.016	16	10	75	50	20,30
1619.017	17	10	75	50	21,20
1619.018	18	10	75	50	21,25
1619.020	20	10	75	50	22,15
1619.022	22	10	75	50	25,95
1619.026	26	10	75	50	27,20
1619.032	32	10	75	50	29,40



centre drill bit for Bormax prima long

Art.- No.	Description	€
1619.208	HSS centre drill bit with shank-Ø 8 mm	17,40
1619.210	HSS centre drill bit with shank-Ø 10 mm	17,40



pre-drill bit for Bormax prima long

Art.- No.	Description	€
1614.208	HSS pre-drill bit Ø 8 mm for Ø 20 - 40 mm	17,40
1614.210	HSS pre-drill bit Ø 10 mm for Ø 44,45 - 120 mm	17,40



Adjustable stop for Bormax prima long

Art.- No.	Description	€
1619.100	depth stop for Ø 40 - 90 mm	118,85

	Stepped guiding pin with shank of 8 or 10 mm x 25 mm		To be used with counterbore product lines 1614 or 1618. Ensures the good guidance of the counterbore tools
	Tool steel		Ground slightly undersized so that easy working is ensured
	please see drill range 1614 and 1619		Packing unit = 1, Rose-tube



NEW



Bormax³ TCT prima









Art.- No.	O-Ø [mm]	Stem Ø [mm]	SØ [mm]	OAL [mm]	Effective L. [mm]	HS	€
1664.015	15	10	10	90	57	1	68,40
1664.020	20	10	10	90	57	1	69,95
1664.025	25	10	10	90	57	2	71,65
1664.030	30	12	10	90	57	2	73,30
1664.035	35	12	10	90	57	2	76,30
1664.040	40	14	10	90	57	2	88,90
1664.045	45	16	10	90	57	2	112,15
1664.050	50	18	10	90	57	2	127,20

Accessory

Art.- No.	Description	O-Ø [mm]	SØ [mm]	OAL [mm]	Effective L. [mm]	PU [pcs]	€
1624.004	pre-drill bit	4	4	45	30	1	3,75
1624.104	pre-drill bit (PU 4)	4	4	45	30	4	13,40
1624.005	Centre point	4	4	45	30	1	3,05
1624.105	Centre point (PU 4)	4	4	45	30	4	11,00

Sets

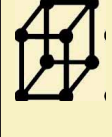
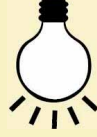
Art.- No.	Description	€
1664.505	5 pcs set in wooden case Ø 15, 20, 25, 30, 35 mm	323,70
1664.506	6 pcs set in wooden case Ø 15, 20, 25, 30, 35 mm incl. extension 125 mm	345,35
1664.606	6 pcs set in wooden case Ø 15, 20, 25, 30, 35, 40 mm	403,65
1664.570	7 pcs set in wooden case Ø 15, 20, 25, 30, 35, 40, 50 mm	518,25
1664.508	8 pcs set in wooden case Ø 15, 20, 25, 30, 35, 40, 45, 50 mm	619,15
1664.509	9 pcs set in wooden case Ø 15, 20, 25, 30, 35, 40, 45, 50 mm incl. extension 250 mm	643,80
1664.504	4 pcs set in wooden case Ø 35, 40, 45, 50 mm	364,10

	<p>TCT Bormax prima with exchangeable centre point and pre-drill bit. The two carbide tipped main cutting edges ensure a maximum service life also in hard and coated materials. Included in the delivery: Bormax, exchangeable centre point, pre-drill bit Ø 4 mm and one allen key. Hexagonal shank for a better power transfer</p>		<p>Clean drilling at many angles in all wood materials like European and exotic hard wood (also Bongossi), MDF, coated and uncoated chipboards, as well as many plastics, such as acrylic glass, Corian, GFRP, HPL coating, polycarbonate, PVC and Trespa board</p>
	<p>TCT (main cutting edges), pre-drill HSS-G</p>		<p>In combination with extension shanks product line 1639 perfectly suitable for drilling deep holes</p>
	<p>1800 - 5000 rpm. e.g. Ø 35 mm 3000 rpm in European hard wood. Further details in the speed diagram</p>		<p>Packing Unit = 1, Blister pack</p>

1663









Excellent
TCT-Bormax³, Forstner Bit
FAMAG[®]
...für Besserbohrer[®]

Art.- No.	O-Ø [mm]	AØ [Inch]	Stem Ø [mm]	SØ [mm]	OAL [mm]	Effective L. [mm]	HS	€
1663.015	15		8	8	90	57	1	59,50
1663.219	15,88	5/8	8	8	90	57	1	61,45
1663.016	16		8	8	90	57	1	61,10
1663.018	18		8	8	90	57	1	61,10
1663.019	19		8	8	90	57	1	61,10
1663.221	19,05	3/4	8	8	90	57	1	61,10
1663.020	20		8	8	90	57	1	61,10
1663.022	22		10	10	90	57	1	62,75
1663.223	22,23	7/8	10	10	90	57	1	62,75
1663.023	23		10	10	90	57	1	62,75
1663.024	24		10	10	90	57	1	62,75
1663.025	25		10	10	90	57	2	62,75
1663.225	25,4	1	10	10	90	57	2	64,40
1663.026	26		10	10	90	57	2	62,75
1663.028	28		12	10	90	57	2	64,40
1663.227	28,58	1 1/8	12	10	90	57	2	67,40
1663.030	30		12	10	90	57	2	64,40
1663.229	31,75	1 1/4	12	10	90	57	2	64,40
1663.032	32		12	10	90	57	2	64,40
1663.231	34,93	1 3/8	12	10	90	57	2	67,35
1663.035	35		12	10	90	57	2	67,40
1663.038	38		14	10	90	57	2	80,00
1663.233	38,10	1 1/2	14	10	90	57	2	80,00
1663.040	40		14	10	90	57	2	80,00
1663.044	44		16	10	90	57	2	109,95
1663.237	44,45	1 3/4	16	10	90	57	2	118,30
1663.045	45		16	10	90	57	2	103,20
1663.050	50		18	10	90	57	2	118,30
1663.241	50,80	2	18	10	90	57	2	130,10
1663.243	53,98	2 1/8	18	10	90	57	2	154,95
1663.054	54		18	10	90	57	2	154,95
1663.060	60		20	13	90	57	2	165,15

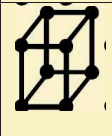
Sets

Art.- No.	Description	€
1663.505	5 pcs. Set in wooden case Ø 15, 20, 25, 30, 35 mm	283,45
1663.606	6 pcs. Set in wooden case Ø 15, 20, 25, 30, 35, 40 mm	355,40
1663.570	7 pcs. Set in wooden case Ø 15, 20, 25, 30, 35, 40, 50 mm	461,80
1663.508	8 pcs. Set in wooden case Ø 15, 20, 25, 30, 35, 40, 45, 50 mm	554,35
1663.504	4 pcs. Set in wooden case Ø 35, 40, 45, 50 mm	331,75





	The first carbide tipped Forstner bit with centre point, carbide-tipped main cutting edge and toothed circumferential cutter. Hexagonal shank for a better power transfer		Freehand drilling in all types of wood: European and exotic wood (also Bongossi), MDF, panel materials, as well as laminated materials and many plastics, such as acrylic glass, Corian, GFRP, HPL coating, polycarbonate, PVC and Trespa board
	TCT (main cutting edge and taper tap)		The first universal carbide tipped drill bit for freehand drilling and of course also for stationary use. In combination with extension shanks perfectly suitable for drilling deep holes
	1800 - 5000 rpm. e.g. Ø 35 mm 3000 rpm in European hard wood. Further details in the speed diagram		Packing unit = 1, Blister pack



Art.- No.	O-Ø [mm]	Stem Ø [mm]	SØ [mm]	OAL [mm]	Effective L. [mm]	€
1662.008	8	7	10	90	57	51,25
1662.010	10	8	10	90	57	51,25
1662.011	11	8	10	90	57	54,55
1662.012	12	8	10	90	57	54,55
1662.013	13	8	10	90	57	61,45
1662.014	14	10	10	90	57	61,45
1662.015	15	10	10	90	57	61,45
1662.016	16	10	10	90	57	63,10
1662.017	17	10	10	90	57	63,10
1662.018	18	10	10	90	57	63,10
1662.019	19	10	10	90	57	63,10
1662.020	20	10	10	90	57	63,10
1662.021	21	10	10	90	57	64,80
1662.022	22	10	10	90	57	64,80
1662.023	23	10	10	90	57	64,80
1662.024	24	10	10	90	57	64,80
1662.025	25	12	10	90	57	64,80
1662.026	26	12	10	90	57	64,80
1662.027	27	13	10	90	57	83,30
1662.028	28	13	10	90	57	66,50
1662.029	29	13	10	90	57	83,30
1662.030	30	13	10	90	57	66,50
1662.031	31	13	10	90	57	87,25
1662.032	32	14	10	90	57	69,60
1662.033	33	14	10	90	57	95,95
1662.034	34	14	10	90	57	69,60
1662.035	35	14	10	90	57	69,60
1662.036	36	14	10	90	57	69,60
1662.037	37	14	10	90	57	103,00
1662.038	38	14	10	90	57	82,60
1662.039	39	16	10	90	57	103,00
1662.040	40	16	10	90	57	82,60
1662.042	42	18	10	90	57	103,60
1662.043	43	18	10	90	57	113,55
1662.044	44	18	10	90	57	113,55
1662.045	45	18	10	90	57	106,60
1662.046	46	18	10	90	57	123,70
1662.048	48	18	10	90	57	128,35
1662.050	50	18	10	90	57	122,15
1662.055	55	18	13	90	57	145,00
1662.058	58	18	13	90	57	164,85
1662.060	60	18	13	90	57	170,60

Sets

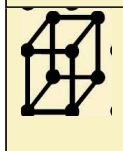
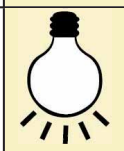
Art.- No.	Description	€
1662.505	5 pcs. Set in wooden case Ø 15, 20, 25, 30, 35 mm	292,70
1662.606	6 pcs. Set in wooden case Ø 15, 20, 25, 30, 35, 40 mm	367,00
1662.508	8 pcs. Set in wooden case Ø 15, 20, 25, 30, 35, 40, 45, 50 mm	572,70
1662.510	10 pcs. Set in wooden case Ø 10, 15, 18, 20, 22, 25, 26, 30, 35, 40	642,90
1662.515	15 pcs. Set in wooden case Ø 10, 12, 15, 16, 18, 20, 22, 25, 26, 30, 35, 40, 45, 50 mm	957,45

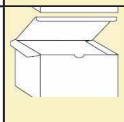
	<p>Carbide tipped with centre point, two main cutting edges, two taper taps. Precisely ground by diamond wheel on CNC machines. High quality carbide tipping and special curved grinding (> Ø 23 mm) on the main cutting edges</p>		<p>Tear free, accurate drillings in all hard wood materials, coated and plastic coated chipboards, as well as many plastics, such as acrylic glass, Corian, GFRP, HPL coating, polycarbonate, PVC and Trespa board. Very good chip removal due to serrated grinding on main cutting edges. For stationary use only</p>
	<p>TCT (main cutting edges and taper tap)</p>		<p>Drilling with nearly no effort as well as an unbelievable service life, also for use in hard wood and hard plastics. For freehand drilling we recommend the TCT-Bormax³ (product line 1663)</p>
	<p>1500 - 8000 rpm. e.g. Ø 35 mm 3000 rpm in European hard wood. Further details in the speed diagram</p>		<p>Packing unit = 1, Rose-tube (up to Ø 55 mm)</p>

1661

○○○○
Excellent

TCT-Cylinder Boring Bit, Long Version



Art.- No.	O-Ø [mm]	Stem Ø [mm]	SØ [mm]	OAL [mm]	Effective L. [mm]	€
1661.010	10	8	13	140	90	77,75
1661.012	12	8	13	140	90	77,75
1661.014	14	8	13	140	90	78,90
1661.015	15	8	13	140	90	78,90
1661.016	16	8	13	140	90	80,95
1661.017	17	8	13	140	90	81,85
1661.018	18	8	13	140	90	81,85
1661.019	19	8	13	140	90	85,15
1661.020	20	8	13	140	90	85,15
1661.022	22	10	13	140	90	87,30
1661.024	24	10	13	140	90	91,45
1661.025	25	10	13	140	90	93,55
1661.026	26	10	13	140	90	94,55
1661.028	28	13	13	140	90	99,85
1661.030	30	13	13	140	90	102,00
1661.032	32	13	13	140	90	107,50
1661.034	34	16	13	140	90	117,95
1661.035	35	16	13	140	90	121,35
1661.036	36	16	13	140	90	128,60
1661.038	38	16	13	140	90	130,20
1661.040	40	16	13	140	90	136,20
1661.042	42	16	16	140	90	149,45
1661.045	45	16	16	140	90	154,15
1661.048	48	16	16	140	90	170,00
1661.050	50	18	16	140	90	165,15
1661.055	55	18	16	140	90	170,60
1661.058	58	18	16	140	90	185,80
1661.060	60	18	16	150	100	185,80
1661.062	62	18	16	160	110	232,25
1661.065	65	18	16	160	110	216,80
1661.068	68	20	16	140	120	232,25
1661.070	70	20	16	160	110	232,25
1661.075	75	20	16	160	110	278,75
1661.080	80	20	16	160	110	278,75
1661.085	85	20	16	160	110	348,40
1661.090	90	25	20	160	110	348,40
1661.095	95	25	20	160	110	433,60
1661.100	100	25	20	160	110	433,60
1661.120	120	25	20	160	110	503,30





	<p>Long version, carbide tipped with centre point, two main cutting edges, two taper taps. Precisely ground by diamond wheel in CNC machines. High quality carbide tipping and special curved grinding (> Ø 23 mm) on the main cutting edges</p>		<p>Tear free, accurate drillings in all hard wood materials, laminated and plastic laminated chipboards, as well as many plastics, such as acrylic glass, Corian, GFRP, HPL coating, polycarbonate, PVC and Trespa board. For stationary use only</p>
	<p>TCT (main cutting edges and taper tap)</p>		<p>For freehand drilling in European hard wood we recommend the long version of Bormax® 2.0 WS prima, our product line 1614</p>
	<p>600 - 6000 rpm. e.g. Ø 68 mm 1300 rpm in European hard wood. Further details in the speed diagram</p>		<p>Packing unit = 1, yellow cardboard tube (up to Ø 100 mm)</p>



Art.- No.	O-Ø [mm]	AØ [Inch]	Stem Ø [mm]	SØ [mm]	OAL [mm]	Effective L. [mm]	€
1630.213	6,35	1/4"	4,5	8	90	57	17,65
1630.214	7,94	5/16"	8	8	90	57	17,65
1630.215	9,53	3/8"	8	8	90	57	17,65
1630.010	10		8	8	90	57	15,55
1630.216	11,11	7/16"	8	8	90	57	16,50
1630.012	12		8	8	90	57	16,05
1630.217	12,70	1/2"	8	8	90	57	18,50
1630.014	14		8	8	90	57	16,75
1630.218	14,29	9/16"	8	8	90	57	17,95
1630.015	15		8	8	90	57	17,35
1630.219	15,88	5/8"	8	8	90	57	19,15
1630.016	16		8	8	90	57	17,40
1630.220	17,46	11/16"	8	8	90	57	18,95
1630.018	18		8	8	90	57	18,55
1630.221	19,05	3/4"	8	8	90	57	21,50
1630.020	20		8	8	90	57	19,45
1630.222	20,64	13/16"	8	8	90	57	21,50
1630.022	22		10	10	90	57	20,95
1630.223	22,23	7/8"	10	10	90	57	23,10
1630.224	23,81	15/16"	10	10	90	57	22,95
1630.024	24		10	10	90	57	22,15
1630.025	25		10	10	90	57	23,50
1630.225	25,40	1"	10	10	90	57	25,95
1630.026	26		10	10	90	57	24,55
1630.027	27		10	10	90	57	27,20
1630.028	28		12	10	90	57	27,20
1630.227	28,58	1 1/8"	12	10	90	57	29,95
1630.030	30		12	10	90	57	27,75
1630.228	30,16	1 3/16"	12	10	90	57	34,00
1630.229	31,75	1 1/4"	12	10	90	57	34,00
1630.032	32		12	10	90	57	30,95
1630.230	33,34	1 5/16"	10	10	90	57	33,60
1630.034	34		12	10	90	57	32,35
1630.231	34,93	1 3/8"	12	10	90	57	33,60
1630.035	35		12	10	90	57	33,60
1630.232	36,51	1 7/16"	14	10	90	57	36,75
1630.038	38		14	10	90	57	36,80
1630.233	38,05	1 1/2"	14	10	90	57	36,75
1630.040	40		14	10	90	57	40,25
1630.235	41,28	1 5/8"	14	10	90	57	53,95
1630.237	44,45	1 3/4"	16	10	90	57	53,95
1630.045	45		16	10	90	57	49,05
1630.239	47,63	1 7/8"	16	10	90	57	53,95
1630.050	50		18	10	90	57	53,10
1630.241	50,80	2"	18	10	90	57	58,35
1630.243	53,98	2 1/8"	18	10	90	57	85,60
1630.245	57,15	2 1/4"	20	10	90	57	88,35

Sets

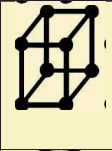
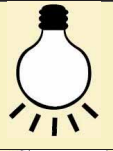
Art.- No.	Description	€
1630.505	5 pcs. Set in wooden case Ø 15, 20, 25, 30, 35 mm	109,25
1630.508	8 pcs. Set in wooden case Ø 15, 20, 25, 30, 35, 40, 45, 50 mm	237,25
1630.510	10 pcs. Set in wooden case Ø 10, 15, 18, 20, 22, 25, 26, 30, 35, 40	241,25
1630.515	15 pcs. Set in wooden case Ø 10, 12, 15, 16, 18, 20, 22, 25, 26, 28, 30, 35, 40, 45, 50 mm	363,00
1630.607	7 pcs. Set in wooden case Ø 1/4, 3/8, 1/2, 5/8, 3/4, 7/8, 1"	128,65
1630.616	16 pcs. Set in wooden case Ø 1/4, 3/8, 1/2, 5/8, 3/4, 7/8, 1, 1.1/8, 1.1/4, 1.3/8, 1.1/2, 1.5/8, 1.3/4, 1.7/8, 2, 2.1/8"	530,50

	Traditional Forstner bit with centre point, two main cutting edges and circumferential cutter. Low friction due to the reduced peripheral cutting edge		Tear free accurate holes in soft wood, glued laminated timber etc. Specially suitable for freehand boring with a drilling machine
	Alloyed tool steel		This bit obtained the first position in an important test of Forstner bits in the U.S. published in "Fine Woodworking 04.2008". For hard wood we recommend the rapid Forstner bit Bormax® of our product line 1622 or the TCT-Bormax³ of our product line 1663
	700 - 2800 rpm. e.g. Ø 35 mm 1000 rpm in soft wood. Further details in the speed diagram		Packing unit = 1, Rose-tube

1633

 Classic

Cylinder Boring Bit



Art.- No.	O-Ø [mm]	Stem Ø [mm]	SØ [mm]	OAL [mm]	Effective L. [mm]	€
1633.010	10	8	8	90	57	15,55
1633.012	12	8	8	90	57	16,05
1633.014	14	8	8	90	57	16,75
1633.015	15	8	8	90	57	17,35
1633.016	16	8	8	90	57	17,40
1633.018	18	8	8	90	57	18,55
1633.020	20	8	8	90	57	19,45
1633.022	22	10	10	90	57	20,95
1633.023	23	10	10	90	57	22,15
1633.024	24	10	10	90	57	22,15
1633.025	25	10	10	90	57	23,50
1633.026	26	10	10	90	57	24,55
1633.028	28	12	10	90	57	27,20
1633.030	30	12	10	90	57	27,75
1633.032	32	12	10	90	57	30,95
1633.034	34	12	10	90	57	32,35
1633.035	35	12	10	90	57	33,60
1633.036	36	12	10	90	57	32,95
1633.038	38	12	10	90	57	34,80
1633.040	40	14	10	90	57	40,25
1633.045	45	16	10	90	57	49,05
1633.050	50	18	10	90	57	53,10
1633.060	60	20	10	90	57	101,95

Sets

Art.- No.	Description	€
1633.505	5 pcs. Set in wooden case Ø 15, 20, 25, 30, 35 mm	109,25
1633.510	10 pcs. Set in wooden case Ø 10, 15, 18, 20, 22, 25, 26, 30, 35, 40 mm	216,85
1633.515	15 pcs. Set in wooden case Ø 10, 12, 15, 16, 18, 20, 22, 25, 26, 28, 30, 35, 40, 45, 50 mm	363,00

	<p>Traditional cylinder boring bit with centre point, two main cutting edges and two taper taps</p>		<p>Tear free accurate holes in soft wood, can also be used for European hard wood and veneered boards. Especially easy to resharpen due to the straight taper taps. Stationary deep-hole drilling is possible with our extension shank product line 1639</p>
	<p>Alloyed tool steel</p>		<p>Cylinder boring bits are only suitable for stationary operation. For freehand drilling we recommend our rapid Forstner bit Bormax product line 1622 or the TCT-Bormax³ product line 1663</p>
	<p>700 - 3000 rpm. e.g. Ø 15 mm 2300 rpm in soft wood. Further details in the speed diagram</p>		<p>Packing unit = 1, Rose-tube</p>







Art.- No.	Description	€
1621.108	Depth Stop for 1622, 1623, 1630, 1663, Drills-Ø 10 - 21 mm	41,60
1621.110	Depth Stop for 1622, 1623, 1630, 1663, Drills-Ø 28 - 35 mm	41,60
1621.112	Depth Stop for 1622, 1623, 1630, 1663, Drills-Ø 28 - 35 mm	41,60
1621.114	Depth Stop for 1622, 1623, 1630, 1663, Drills-Ø 36 - 40 mm	41,60
1621.116	Depth Stop for 1622, 1623, 1630, 1663, Drills-Ø 42 - 48 mm	41,60

Sets

Art.- No.	Description	€
1621.200	Depth Stop Set for 1622,1630,1663, for drills-Ø 10 - 48 mm, incl. a nipper	106,60

Accessory

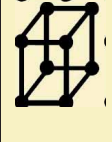
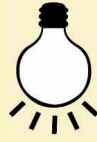
Art.- No.	Description	€
1621.100	Depth Stop single for 1622, 1623, 1630, 1663	27,75
1621.001	Plier for locking ring	18,15
1621.008	Guide bush I-Ø 8 mm for 1621.100	13,90
1621.010	Guide bush I-Ø 10 mm for 1621.100	13,90
1621.012	Guide bush I-Ø 12 mm for 1621.100	13,90
1621.014	Guide bush I-Ø 14 mm for 1621.100	13,90
1621.016	Guide bush I-Ø 16 mm for 1621.100	13,90

	Depth stop supported by ball bearing for FAMAG-Forstner bits with exchangeable guide bushings		The depth stop is mounted on the stalk and the drilling depth has to be adjusted. This makes it possible to drill stud holes with exactly the same depth at all times. The bushings are rotatably supported by ball bearings and thus produce no disturbing marks on the workpiece surface
	Depth Stop made of resistant ABS plastic, guide bushing made of steel		For larger drilling depths, it is possible to mount the guide bushing in reverse form, so that you can reach a larger adjustment of the depth stop
	see speed of Forstner bit		Packing unit = 1

1616

Profi

Disc + Plug Cutter

FAMAG
für Besserbohrer



Art.- No.	∅ [mm]	S∅ [mm]	O-∅ [mm]	Teeth	OAL [mm]	Effective L. [mm]	€
1616.006	6	13	16	4	140	70	74,60
1616.008	8	13	18	4	140	70	74,60
1616.009	9	13	19	4	140	70	87,90
1616.010	10	13	20	4	140	70	61,05
1616.011	11	13	21	4	140	70	87,90
1616.012	12	13	22	4	140	70	66,10
1616.013	13	13	23	4	140	70	87,90
1616.014	14	13	24	4	140	70	66,10
1616.015	15	13	25	4	140	70	66,10
1616.016	16	13	26	4	140	70	70,95
1616.018	18	13	28	4	140	70	70,95
1616.020	20	13	30	4	140	70	70,95
1616.022	22	13	32	4	140	70	78,90
1616.024	24	13	36	5	140	70	104,00
1616.025	25	13	37	5	140	70	79,10
1616.026	26	13	38	5	140	70	115,15
1616.028	28	13	40	5	140	70	115,15
1616.030	30	13	42	5	140	70	86,35
1616.032	32	13	44	5	140	70	132,20
1616.034	34	13	48	6	140	70	132,20
1616.035	35	13	49	6	140	70	95,95
1616.036	36	16	50	6	140	70	142,85
1616.040	40	16	54	6	140	70	109,80
1616.045	45	16	59	6	140	70	122,10
1616.050	50	16	64	6	140	70	138,60
1616.055	55	16	69	6	140	70	209,50
1616.060	60	16	74	6	140	70	209,50
1616.065	65	16	79	6	140	70	315,10
1616.070	70	16	84	8	140	70	315,10
1616.080	80	16	94	9	140	70	407,10

Sets

Art.- No.	Description	€
1616.505	5 pcs. Set in wooden case ∅ 15, 20, 25, 30, 35 mm	359,65
1628.306	6 pcs. Set in wooden case with Plug Cutter 1616: ∅ 15, 20, 25 mm and Bormax 1622: ∅ 15, 20, 25 mm	260,60
1629.308	8 pcs. Set in wooden case with Plug Cutter 1616 and Brad point drill bit HSS-G 1594, each ∅ 6, 8, 10 and 12 mm	289,00
1629.306	6 pcs. Set in wooden case with Plug Cutter 1616 incl. Bormax 2.0 WS prima 1624 each ∅ 15, 20, 25 mm	285,15

	Twofold ground main cutting edges and circumferential cutters. Effective length of the plug max. 70 mm		For the production of plugs for filling knot holes or fixing partial wood damage in combination with Bormax®. For precise fitting use FAMAG drill bits
	Alloyed tool steel		Place 1616 at the edge of the workpiece in a way that the circular ring is opened sideways and a good removal of the chips is guaranteed
	400 - 1500 rpm e.g. ∅ 15 mm 1000 rpm in soft wood		Packing unit = 1, Blister pack, from ∅ 35 in rose-box, from ∅ 55 in yellow cardboard tube

1616.2

Profi

Disc + Plug Cutter



Art.- No.	∅ [mm]	∅ [Inch]	O-∅ [mm]	Teeth	S∅ [mm]	OAL [mm]	Effective L. [mm]	€
1616.215	9,53	3/8	19,53	4	13	140	70	94,45
1616.217	12,70	1/2	22,70	4	13	140	70	94,45
1616.219	15,88	5/8	25,88	4	13	140	70	94,45
1616.221	19,05	3/4	29,05	4	13	140	70	94,45
1616.223	22,23	7/8	32,23	4	13	140	70	99,70
1616.225	25,40	1	37,40	5	13	140	70	99,70
1616.231	34,93	1 3/8	48,93	6	13	140	70	121,60

	Twofold ground main cutting edges and circumferential cutters. Effective plug length is max. 2 inch		For the plug production for filling knot holes or fixing partial wood damage in combination with Bormax®. For precise fitting use FAMAG drill bits
	Alloyed tool steel		Place 1616 at the workpiece's edge in a way that the circular ring is opened sidewise and a good removal of the chips is guaranteed
	400 - 1000 rpm. e.g. ∅ 1/2 inch 1200 rpm in soft wood		Packing unit = 1, Blister pack

1616.1

Excellent

TCT-Disc + Plug Cutter



Art.- No.	∅ [mm]	S∅ [mm]	O-∅ [mm]	Teeth	OAL [mm]	Effective L. [mm]	€
1616.115	15	13	25	4	140	70	178,60
1616.120	20	13	30	4	140	70	185,15
1616.125	25	13	37	5	140	70	191,15
1616.130	30	13	42	5	140	70	197,15
1616.135	35	13	49	6	140	70	201,95
1616.140	40	16	54	6	140	70	221,00
1616.150	50	16	64	6	140	70	286,65

	Twofold by robots relief ground main cutting edges and circumferential cutters. Total length 140 mm. Effective length of the plug max. 70 mm. Precisely ground by diamond wheel on CNC		For the plug production of European and exotic hardwood. Also applicable for some plastics like acrylic glass, Corian, GFRP, HPL coating, polycarbonate, PVC and Trespa board . Long service life
	TCT (main cutting edges and circumference cutter)		Place 1616 at the edge of the work piece in a way that the outside of the cutter is overlapping the edge, allowing fast chip ejection
	1500 - 2000 rpm. e.g. ∅ 15 mm 1800 rpm in European hard wood		Packing unit = 1, Blister pack

Technical changes or mistakes reserved! All prices are recommended retail prices additionally value added tax.

1639

Profi

Extension



Art.- No.	∅ [mm]	O-∅ [mm]	S∅ [mm]	OAL [mm]	Effective L. [mm]	€
1639.011	8	16	10	80	50	22,20
1639.003	8	16	10	125	100	24,85
1639.004	8	16	10	250	220	27,50
1639.010	10	16	10	80	50	22,20
1639.001	10	16	10	125	100	24,85
1639.002	10	16	10	250	220	27,50
1639.009	10	22	13	400	360	44,95
1639.007	12	22	13	400	360	44,95
1639.005	13	22	13	125	100	27,50
1639.006	13	22	13	250	220	31,15
1639.008	13	22	13	400	360	44,95

Sets

Art.- No.	Description	€
1639.583	3 pcs. Set in wooden case ∅ 10mm, GL 80, 125, 250	67,05
1639.503	3 pcs. Set in wooden case ∅ 8mm, GL 80, 125, 250	67,05

	∅ of the shank 10 mm, or 13 x 30 mm. With four attachment screws for fixing. Solid quality. The shank of ∅ 13 mm has three clamping surfaces		For the extension of all cylinder boring bits or all tools with ∅ of shank 8, 10, 12, 13 mm
	Tool steel		Perfect for drilling deep holes, also for turnery. Only limited suitable for drilling end grain (especially hard wood) because there is considerable strain on the drill chuck
	In combination with extensions please use less speed		Packing unit = 1, Rose-tube

3514/
3582

Classic

Hinge Drill Bit



With Bormax geometry

Art.- No.	O-Ø [mm]	SØ [mm]	OAL [mm]	Effective L. [mm]	€
3514.026	26	10	60	40	17,00
3514.035	35	10	60	40	17,00

Alloyed tool-steel version

Art.- No.	O-Ø [mm]	SØ [mm]	OAL [mm]	Effective L. [mm]	€
3515.026	26	8	60	40	11,20
3515.030	30	8	60	40	11,60
3515.035	35	8	60	40	11,70

TCT version

Art.- No.	O-Ø [mm]	SØ [mm]	OAL [mm]	Effective L. [mm]	€
3516.015	15	8	60	40	21,20
3516.020	20	8	60	40	21,20
3516.025	25	8	60	40	20,40
3516.026	26	8	60	40	20,40
3516.030	30	8	60	40	21,20
3516.035	35	8	60	40	20,40

Self centering hinge drill bit Zenterfix

Art.- No.	O-Ø [mm]	SØ [mm]	OAL [mm]	Effective L. [mm]	€
3582.020	2,0	E 6,3	84	14	17,65
3582.030	2,75	E 6,3	86	14	18,00
3582.035	3,5	E 6,3	95	15	19,30

Spare drill bit for Zenterfix

Art.- No.	Description	O-Ø [mm]	€
3582.120	spare drill bit HSS for 3582.020	2,0	1,30
3582.130	spare drill bit HSS for 3582.030	2,75	1,70
3582.135	spare drill bit HSS for 3582.035	3,5	1,90

	<p>Small centre point, taper tap and two main cutting edges. The Zenterfix is equipped with a guide bush incl. spring and a core drill HSS with roof tip</p>		<p>Tear free accurate hinge drillings. The tool steel version for uncoated soft wood. The Bormax® - geometry for coated boards and limited for plastic laminated chipboards or MDF. Carbide tipped version can be used without problems for plastic coated materials. The Zenterfix will centre itself in a screw hole of a fitting or a hinge</p>
	<p>Alloyed tool steel or TCT (main cutting edge and taper tap)</p>		<p>Only the BORMAX - geometry tools are suitable for freehand drilling. When using Bormax® on coated boards, let the power drill run very slowly so that the teeth can tear the coating open and the drill won't be damaged by too much heat</p>
	<p>1000 rpm for Tool steel-types. 2500 rpm for TCT-types. Further details in the speed diagram</p>		<p>Packing unit = 1, Rose-tube</p>



Technical changes or mistakes reserved! All prices are recommended retail prices additionally value added tax.

1607

Profi

Spiral Slot Milling Cutter

FAMAG
...für Besserbohrer®



version with shank Ø 13mm

Art.- No.	O-Ø [mm]	SØ [mm]	OAL [mm]	SpL [mm]	€
1607.106	6	13	120	40	24,90
1607.108	8	13	130	40	25,85
1607.110	10	13	140	45	28,20
1607.112	12	13	150	50	29,25
1607.114	14	13	160	55	30,70
1607.116	16	13	170	65	34,10

version with shank Ø 16mm

Art.- No.	O-Ø [mm]	SØ [mm]	OAL [mm]	SpL [mm]	€
1607.206	6	16	120	40	24,90
1607.208	8	16	130	40	25,85
1607.210	10	16	140	45	28,20
1607.212	12	16	150	50	29,25
1607.214	14	16	160	55	30,70
1607.216	16	16	170	65	34,10

Sets

Art.- No.	Description	€
1607.606	6 pcs. Set in wooden case Ø 6, 8, 10, 12, 14, 16 mm, shank Ø 13 mm	155,30

	Two spiraled main cutting edges in fully ground quality with stepped cylindrical shank Ø 13 or 16 mm		Milling of slots in soft wood and limited in European hard wood with a slot drilling machine. Higher cutting rate and ideal removal of the chips due to the twisted geometry of the main cutting edges
	Alloyed tool steel		Thanks to the twisted spiral this drill runs particularly smoothly and without any annoying chattering
	2500 - 5000 rpm. e.g. Ø 16 mm 2500 rpm in soft wood. Further details in the speeddiagram		Packing unit = 1, Rose-tube



Shank-Ø 13mm

Art.- No.	Description	O-Ø [mm]	SØ [mm]	OAL [mm]	SpL [mm]	€
1601.105		5	13	115	35	20,35
1601.106		6	13	120	35	18,70
1601.108		8	13	130	40	18,55
1601.110		10	13	140	45	17,70
1601.111		11	13	145	48	18,05
1601.112		12	13	150	50	17,25
1601.113		13	13	155	53	18,20
1601.114		14	13	160	55	18,55
1601.116		16	13	170	60	21,10
1601.118		18	13	180	68	24,70
1601.120		20	13	185	70	31,30
1601.122		22	13	190	75	45,10
1601.124	End of Series	24	13	195	77	51,20

Shank-Ø 16mm

Art.- No.	Description	O-Ø [mm]	SØ [mm]	OAL [mm]	SpL [mm]	€
1601.206		6	16	120	35	18,70
1601.208		8	16	130	40	18,55
1601.210		10	16	140	45	17,70
1601.212		12	16	150	50	17,25
1601.214		14	16	160	55	18,55
1601.216		16	16	170	60	21,10
1601.218		18	16	180	68	24,70
1601.220		20	16	185	70	31,30
1601.222		22	16	190	75	45,10
1601.224	End of Series	24	16	195	77	51,20

1601/03

 Classic

Slot Mortise Bit LH

FAMAG[®]
...für Besserbohrer[®]

Shank - Ø 13 mm

Art.- No.	Description	O-Ø [mm]	SØ [mm]	OAL [mm]	SpL [mm]	€
1601.406		6	13	120	35	18,70
1601.407	End of Series	7	13	120	35	18,55
1601.408		8	13	130	40	18,55
1601.409	End of Series	9	13	130	40	18,55
1601.410		10	13	140	45	17,70
1601.411	End of Series	11	13	140	45	18,05
1601.412		12	13	150	50	17,25
1601.413	End of Series	13	13	150	50	18,20
1601.414		14	13	160	55	18,55
1601.416		16	13	170	60	21,10
1601.418		18	13	180	68	24,70
1601.420		20	13	185	70	31,30
1601.422		22	13	190	75	45,10
1601.424	End of Series	24	13	195	77	51,20

Shank - Ø 16 mm





Art.- No.	Description	O-Ø [mm]	SØ [mm]	OAL [mm]	SpL [mm]	€
1601.506		6	16	120	35	18,70
1601.508		8	16	130	40	18,55
1601.510		10	16	140	45	17,70
1601.512		12	16	150	50	17,25
1601.514		14	16	160	55	18,55
1601.516		16	16	170	60	21,10
1601.518		18	16	180	68	24,70
1601.520		20	16	185	70	31,30
1601.522		22	16	190	75	45,10
1601.524	End of Series	24	16	195	77	51,20

Slot Mortise Bit, RH, for lock casing

Art.- No.	O-Ø [mm]	SØ [mm]	OAL [mm]	SpL [mm]	€
1603.216	16	16	200	130	69,75

Sets

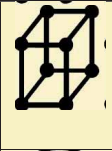
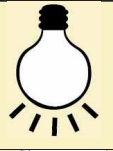
Art.- No.	Description	€
1601.606	6 pcs. Set in wooden case right cutting version Ø 6, 8, 10, 12, 14, 16 mm	100,30

	Two straight main cutting edges with chip breaking flutes. With stepped cylindrical shank Ø 13 or 16 mm		Milling of slots in soft wood with a slot drilling machine. Due to the special geometry of the head piercing use is possible
	Alloyed tool steel		Not appropriate for hard wood. Limited suitable for hard wood is our product line 1607 (curved and fully ground version)
	2200 - 4000 rpm. e.g. Ø 16 mm 2200 rpm in soft wood. Further details in the speed diagram		Packing unit = 1, Rose-tube



OAL 235 mm

Art.- No.	O-Ø [mm]	SØ [mm]	OAL [mm]	SpL [mm]	€
1410.205	5	4,5	235	160	12,40
1410.206	6	5,5	235	160	12,40
1410.207	7	6,5	235	160	12,40
1410.208	8	7,8	235	160	12,40
1410.209	9	8	235	160	12,40
1410.210	10	9,8	235	160	12,40
1410.211	11	9,8	235	160	12,95
1410.212	12	11,8	235	160	12,95
1410.213	13	12,8	235	160	14,15
1410.214	14	13	235	160	14,15
1410.215	15	13	235	160	15,10
1410.216	16	13	235	160	15,10
1410.217	17	13	235	160	16,60
1410.218	18	13	235	160	16,60
1410.219	19	13	235	160	18,35
1410.220	20	13	235	160	18,35
1410.222	22	13	235	160	21,85
1410.224	24	13	235	160	23,65
1410.225	25	13	235	160	27,25
1410.226	26	13	235	160	27,25
1410.228	28	13	235	160	30,45
1410.230	30	13	235	160	33,45
1410.232	32	13	235	160	43,20
1410.234	34	13	235	160	62,90
1410.235	35	13	235	160	70,35
1410.236	36	13	235	160	68,80
1410.238	38	13	235	160	83,60
1410.240	40	13	235	160	93,60
1410.245	45	13	235	160	126,00
1410.250	50	13	235	160	166,05

OAL 320 mm

Art.- No.	O-Ø [mm]	SØ [mm]	OAL [mm]	SpL [mm]	€
1410.305	5	4,5	320	255	16,00
1410.306	6	5,5	320	255	16,00
1410.307	7	6,5	320	255	16,00
1410.308	8	7,8	320	255	16,00
1410.309	9	8	320	255	16,00
1410.310	10	9,8	320	255	16,00
1410.311	11	9,8	320	255	17,55
1410.312	12	11,8	320	255	17,55
1410.313	13	12,8	320	255	18,85
1410.314	14	13	320	255	18,85
1410.315	15	13	320	255	21,45
1410.316	16	13	320	255	21,45
1410.317	17	13	320	255	22,60
1410.318	18	13	320	255	22,60
1410.319	19	13	320	255	26,25
1410.320	20	13	320	255	26,25
1410.322	22	13	320	255	31,50
1410.324	24	13	320	255	32,35
1410.325	25	13	320	255	36,45
1410.326	26	13	320	255	36,45
1410.328	28	13	320	255	40,55
1410.330	30	13	320	255	43,70
1410.332	32	13	320	255	60,35
1410.334	34	13	300	220	85,60
1410.335	35	13	300	220	95,45
1410.336	36	13	300	220	95,45
1410.338	38	13	300	220	126,00
1410.340	40	13	300	220	143,60
1410.345	45	13	300	220	188,50
1410.350	50	13	300	220	243,40

1410

 Profi

Auger Bit, Lewis Pattern

FAMAG®
...für Besserbohrer®

OAL 460 mm

Art.- No.	O-Ø [mm]	SØ [mm]	OAL [mm]	SpL [mm]	€
1410.405	5	4,5	460	380	21,15
1410.406	6	5,5	460	380	21,15
1410.407	7	6,5	460	380	21,15
1410.408	8	7,8	460	380	21,15
1410.409	9	8	460	380	21,15
1410.410	10	9,8	460	380	21,15
1410.411	11	9,8	460	380	21,70
1410.412	12	11,8	460	380	21,70
1410.413	13	12,8	460	380	25,60
1410.414	14	13	460	380	25,60
1410.415	15	13	460	380	28,80
1410.416	16	13	460	380	28,80
1410.417	17	13	460	380	30,60
1410.418	18	13	460	380	30,60
1410.419	19	13	460	380	33,45
1410.420	20	13	460	380	33,45
1410.421	21	13	460	380	41,75
1410.422	22	13	460	380	41,75
1410.423	23	13	460	380	44,55
1410.424	24	13	460	380	45,40
1410.425	25	13	460	380	51,45
1410.426	26	13	460	380	51,45
1410.427	27	13	460	380	57,10
1410.428	28	13	460	380	57,10
1410.430	30	13	460	380	58,45
1410.432	32	13	460	380	75,75
1410.434	34	13	460	380	115,80
1410.435	35	13	460	380	120,80
1410.436	36	13	460	380	118,65
1410.438	38	13	460	380	163,40
1410.440	40	13	460	380	188,50
1410.445	45	13	460	380	248,25
1410.450	50	13	460	380	320,50

OAL 650 mm

Art.- No.	O-Ø [mm]	SØ [mm]	OAL [mm]	SpL [mm]	€
1410.606	6	5,5	650	535	46,65
1410.608	8	7,8	650	535	28,90
1410.609	9	8	650	535	28,90
1410.610	10	9,8	650	535	28,90
1410.611	11	9,8	650	535	29,80
1410.612	12	11,8	650	535	29,80
1410.613	13	12,8	650	535	36,15
1410.614	14	13	650	535	36,15
1410.615	15	13	650	535	40,50
1410.616	16	13	650	535	40,50
1410.617	17	13	650	535	43,30
1410.618	18	13	650	535	43,30
1410.619	19	13	650	535	49,40
1410.620	20	13	650	535	49,40
1410.621	21	13	650	535	58,25
1410.622	22	13	650	535	58,25
1410.624	24	13	650	535	61,75
1410.625	25	13	650	535	69,55
1410.626	26	13	650	535	69,55
1410.628	28	13	650	535	77,30
1410.630	30	13	650	535	85,65
1410.632	32	13	650	535	106,00
1410.634	34	13	650	535	148,85
1410.635	35	13	650	535	156,30
1410.636	36	13	650	535	153,55
1410.638	38	13	650	535	210,80
1410.640	40	13	650	535	243,40
1410.645	45	13	650	535	320,50
1410.650	50	13	650	535	412,80



OAL 1080 mm, spiral length 1010 mm





Art.- No.	O-Ø [mm]	SØ [mm]	OAL [mm]	SpL [mm]	€
1410.014	14	13	1080	1010	116,80
1410.016	16	13	1080	1010	127,85
1410.018	18	13	1080	1010	140,65
1410.020	20	13	1080	1010	149,60
1410.022	22	13	1080	1010	169,05
1410.024	24	13	1080	1010	185,10
1410.026	26	13	1080	1010	204,55
1410.028	28	13	1080	1010	219,55
1410.030	30	13	1080	1010	247,35
1410.032	32	13	1080	1010	264,60

OAL 1000 mm

Art.- No.	O-Ø [mm]	SØ [mm]	OAL [mm]	SpL [mm]	€
1410.112	12	12	1000	380	89,80
1410.114	14	13	1000	380	89,80
1410.115	15	13	1000	380	92,80
1410.116	16	13	1000	380	92,80
1410.118	18	13	1000	380	94,40
1410.120	20	13	1000	380	97,25
1410.122	22	13	1000	380	103,70
1410.124	24	13	1000	380	107,00
1410.125	25	13	1000	380	116,85
1410.126	26	13	1000	380	116,70
1410.128	28	13	1000	380	123,45
1410.130	30	13	1000	380	123,45
1410.132	32	13	1000	380	138,30
1410.134	34	13	1000	535	164,50
1410.135	35	13	1000	535	171,95
1410.136	36	13	1000	535	171,95
1410.138	38	13	1000	535	235,40
1410.140	40	13	1000	535	272,70
1410.145	45	13	1000	535	358,65
1410.150	50	13	1000	535	466,80

Sets

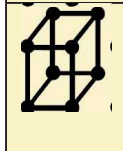
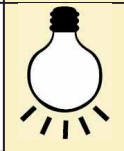
Art.- No.	Description	€
1410.200	8 pcs. Set in wooden case with OAL 235 mm Ø 6, 8, 10, 12, 14, 16, 18, 20 mm	102,50
1410.201	6 pcs. Set in wooden case with OAL 235 mm Ø 10, 12, 14, 16, 18, 20 mm	80,25
1410.300	6 pcs. Set in wooden case with OAL 320 mm Ø 10, 12, 14, 16, 18, 20 mm	110,15
1410.400	6 pcs. Set in wooden case with OAL 460 mm Ø 10, 12, 14, 16, 18, 20 mm	144,80
1410.600	6 pcs. Set in wooden case with OAL 650 mm. Ø 10, 12, 14, 16, 18, 20 mm	205,15
1410.303	8 pcs. Set in wooden case with OAL 320 mm Ø 10, 12, 14, 16, 18, 20, 22, 24 mm	167,10
1410.403	8 pcs. Set in wooden case with OAL 460 mm Ø 10, 12, 14, 16, 18, 20, 22, 24 mm	223,15

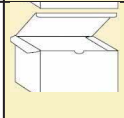
	<p>"Lewis" pattern, crest of thread, main cutting edge and taper tap in premium quality. Version with stepped head and hexagonal shank from Ø 8mm</p>		<p>For drilling deep holes in soft wood and European hard wood with power drill and joinery machine. < Ø 24 mm can also be used with cordless screw driver</p>
	<p>Alloyed tool steel</p>		<p>Due to the precise production of the auger bits, they can also be used for drilling exact holes for stud bolts. For hard wood we recommend our profi product line 1493</p>
	<p>500 - 2800 rpm. e.g. Ø 12 mm 2000 rpm in soft wood. Further details in the speed diagram</p>		<p>Packing unit = 1, Rose-tube up to Ø 36 mm and whole length 650 mm</p>

1411

○○○
Profi

Countersink for Auger Bits 180°

FAMAG[®]
...für Besserbohrer[®]

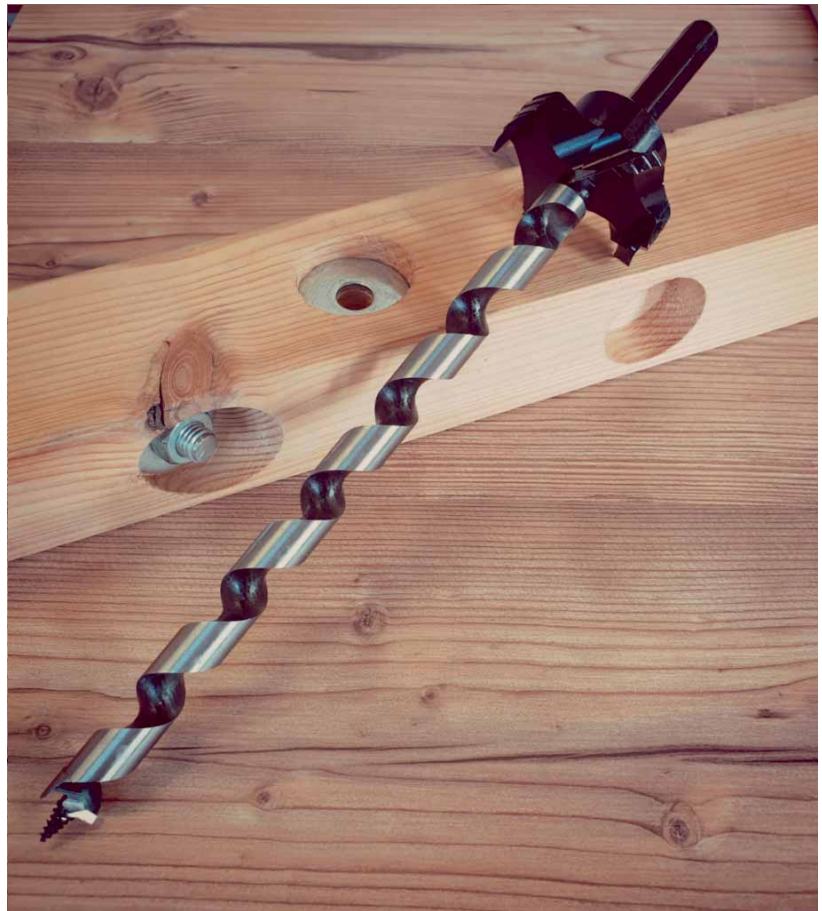

Art.- No.	O-Ø [mm]	lØ [mm]	OAL [mm]	Effective L. [mm]	€
1411.040	40	13	30	30	69,70
1411.050	50	13	30	30	81,20
1411.060	60	13	30	30	103,80
1411.070	70	13	30	30	136,00

Sets

Art.- No.	Description	€
1411.200	Combination Set auger bit / countersink, OAL 235 mm, auger bits 14, 16, 18 mm and countersinks Ø 40, 50, 60 mm	269,00
1411.300	Combination Set auger bit / countersink, OAL 320 mm, auger bits 14, 16, 18 mm and countersinks Ø 40, 50, 60 mm	284,65
1411.400	Combination Set auger bit / countersink, OAL 460 mm, auger bits 14, 16, 18 mm and countersinks Ø 40, 50, 60 mm	303,90





	<p>Two in reverse order staggered, grooved main cutting edges and taper taps with longitudinal grooves - both effecting that a clear less feed rate force is necessary. Also they minimize the friction and the growth of heat. With lateral attachment screw for being fixed on the shanks of FAMAG auger bits</p>		<p>To fit on FAMAG auger bits with shank-Ø 13 mm. Drilling and counterboring in one single operation. Recommended for soft wood</p>
	<p>Alloyed tool steel</p>		<p>Can be used universally on all FAMAG auger bits with shank-Ø 13 mm</p>
	<p>500 - 800 rpm e.g. Ø 40 mm 800 rpm in soft wood. Further details in the speed diagram</p>		<p>Packing unit = 1, Rose-box</p>



Art.- No.	O-Ø [mm]	SØ [mm]	OAL [mm]	SpL [mm]	€
1420.412	12	12	460	400	31,55
1420.413	13	13	460	400	37,40
1420.414	14	13	460	400	37,40
1420.415	15	13	460	400	41,45
1420.416	16	13	460	400	41,45
1420.417	17	13	460	400	43,35
1420.418	18	13	460	400	43,35
1420.419	19	13	460	400	47,30
1420.420	20	13	460	400	47,30
1420.421	21	13	460	400	60,00
1420.422	22	13	460	400	60,00
1420.424	24	13	460	400	63,90
1420.425	25	13	460	400	72,70
1420.426	26	13	460	400	72,70
1420.428	28	13	460	400	78,65
1420.430	30	13	460	400	80,65
1420.432	32	13	460	400	102,30

Sets

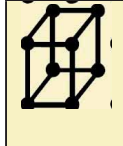
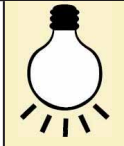
Art.- No.	Description	€
1420.400	6 pcs. Set in wooden case Ø 12 ,14 ,16 ,18, 20, 22 mm	234,55

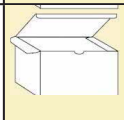
	<p>Premium single-edged auger bit with specially ground tip and very dimensionally stable spirals. Premium coating to ensure minimal friction</p>		<p>For drilling in all soft woods on joinery machines. Due to the spiral's especially sturdy geometry it is also possible to drill exactly into thick joists. Due to the negative tolerance of the drill-Ø a tight fit is guaranteed</p>
	<p>Alloyed tool steel</p>		<p>Due to the head's special geometry it is especially applicable for drilling in planed or finished glued laminated timber. Entry and exit of the drill bit are considerably cleaner than with a usual auger bit</p>
	<p>2800 - 3600 rpm e.g. Ø 18 mm 2800 rpm in glulam (glue laminated timber, on joinery machines)</p>		<p>Packing unit = 1. Rose-tube</p>

1492

 Profi

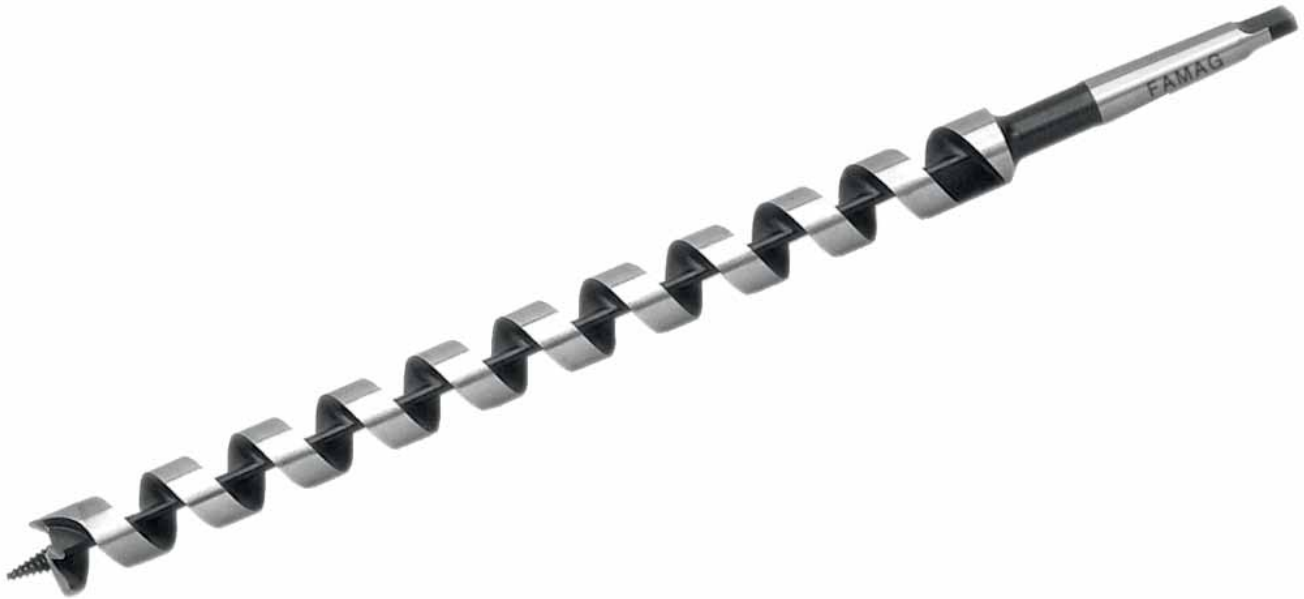

Auger Bit with Morse Cone Shank No. 2

FAMAG®
...für Besserbohrer®
**OAL 480 mm**

Art.- No.	O-Ø [mm]	Shank [mm]	OAL [mm]	SpL [mm]	€
1492.410	10	MK 2	480	380	62,60
1492.412	12	MK 2	480	380	62,60
1492.414	14	MK 2	480	380	69,80
1492.416	16	MK 2	480	380	71,65
1492.418	18	MK 2	480	380	71,65
1492.420	20	MK 2	480	380	71,65
1492.422	22	MK 2	480	380	81,40
1492.424	24	MK 2	480	380	90,35

OAL 680 mm

Art.- No.	O-Ø [mm]	Shank [mm]	OAL [mm]	SpL [mm]	€
1492.610	10	MK 2	650	550	91,30
1492.612	12	MK 2	650	550	91,30
1492.614	14	MK 2	650	550	95,40
1492.616	16	MK 2	650	550	105,30
1492.618	18	MK 2	650	550	105,30
1492.620	20	MK 2	650	550	112,20
1492.622	22	MK 2	650	550	117,70
1492.624	24	MK 2	650	550	126,25
1492.626	26	MK 2	650	550	139,90

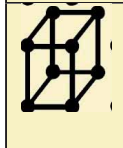
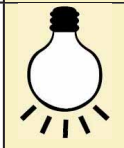
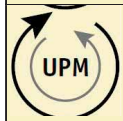
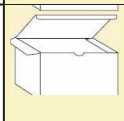

	<p>"Lewis" pattern with crest of thread, main cutting edge and taper tap, morse cone shank No. 2</p>		<p>For drilling precisely fitting holes in all European solid woods. For joinery machines taking up morse cone No. 2</p>
	<p>Alloyed tool steel</p>		<p>For hard wood and exotic hard wood like Bongossi we recommend the auger bit with knife, our product line 1493. Larger diameters can be combined with our product line 1410/1493 and morse cone No. 2 adapter (product line 1488)</p>
	<p>1250 - 2500 rpm e.g. Ø 22 mm 1500 rpm in soft wood. Further details in the speed diagram</p>		<p>Packing unit = 1, Rose-tube</p>



Art.- No.	O-Ø [mm]	SØ [mm]	OAL [mm]	SpL [mm]	€
1494.414	14	12	460	400	60,95
1494.416	16	12	460	400	68,90
1494.418	18	12	460	400	72,90
1494.419	19	12	460	400	79,50
1494.420	20	12	460	400	79,50
1494.424	24	12	460	400	108,20
1494.425	25	12	460	400	108,20

Spare part: crest of thread or centre point

Art.- No.	Description	O-Ø [mm]	€
1494.903	crest of thread for Ø 14 mm	3	6,90
1494.901	crest of thread for Ø 16 - 19mm	4	6,90
1494.902	crest of thread for Ø 20 - 25 mm	5	6,90
1494.906	Centre point for Ø 14 mm	3	6,90
1624.005	Centre point	4	3,05
1494.904	Centre point for Ø 20 - 25 mm	5	6,90

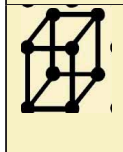
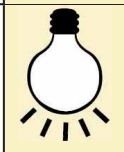
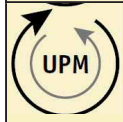
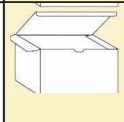
	<p>Specially formed channel for removing chips, teflon-coated, changeable crest of thread HSS, two carbide tipped main cutting edges, protruding cutting edges and cylindrical shank with three clamping surfaces. Ground by diamond wheels on CNC-machines</p>		<p>For drilling precisely fitting holes in hard wood. For exotic hard wood like Bongossi we recommend auger bit product line 1493. Also applicable with a powerful joinery machine for drilling end-grained hard wood</p>
	<p>TCT (main cutting edge), changeable crest of thread HSS</p>		<p>Unbelievable service life in hard wood</p>
	<p>1750 - 3000 rpm e.g. Ø 18 mm 2250 rpm in European hard wood. Further details in the speed diagram</p>		<p>Packing unit = 1, Rose-tube</p>

1493

○○○
Profi

Auger Bit for Hard Wood

FAMAG[®]
...für Besserbohrer[®]



Art.- No.	O-Ø [mm]	SØ [mm]	OAL [mm]	SpL [mm]	€
1493.408	8	8	460	380	33,75
1493.410	10	10	460	380	33,75
1493.412	12	12	460	380	34,70
1493.414	14	13	460	380	40,85
1493.416	16	13	460	380	46,20
1493.418	18	13	460	380	48,90
1493.420	20	13	460	380	53,45
1493.422	22	13	460	380	66,55
1493.424	24	13	460	380	72,65
1493.426	26	13	460	380	82,30
1493.428	28	13	460	380	91,30
1493.430	30	13	460	380	93,40

Sets

Art.- No.	Description	€
1493.400	6 pcs. in wooden case Ø 10, 12, 14, 16, 18, 20 mm	231,70

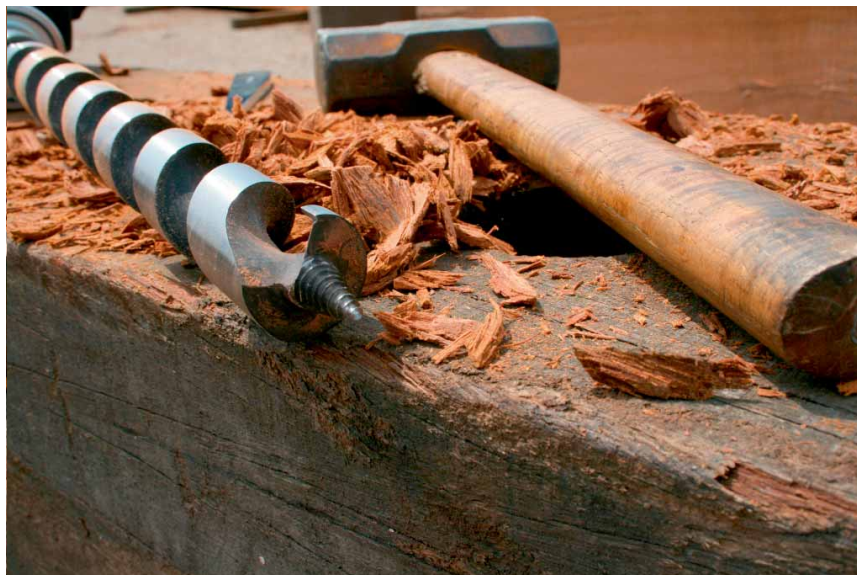

	"Lewis" pattern with crest of thread, main cutting edge and bottom blade		For drilling deep holes in all hard woods and also in Bongossi
	Alloyed tool steel		Due to the special knife you have a low heat development, which guarantees a long service life. For drilling in soft wood we recommend product line 1410
	700 - 2250 rpm e.g. Ø 12 mm 1500 rpm in European hard wood. Further details in the speed diagram		Packing unit = 1, Rose-tube

**Kombifix version**

Art.- No.	Ø [mm]	Shank [mm]	OAL [mm]	Effective L. [mm]	€
1489.001	MK 1	10	125	90	57,70
1489.002	MK 2	13	135	100	60,95





**ZB-fix version**

Art.- No.	Ø [mm]	Shank [mm]	OAL [mm]	Effective L. [mm]	€
1489.613	13	ZB	100	60	62,80

**Morse Cone 2-fix version**

Art.- No.	Ø [mm]	Shank [mm]	OAL [mm]	Effective L. [mm]	€
1488.210	10	MK 2	120	40	44,20
1488.213	13	MK 2	120	40	44,20

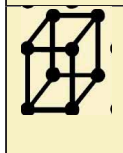
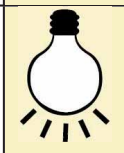

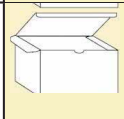
	<p>Adapter, external morse cone No. 2 or Mafell-ZB (inside cylindrical) with two attachment screws. Kombi-Fix inside morse cone, outside cylindrical with hexagonal shank</p>		<p>For joinery machines taking up morse cone No. 2/mafell-ZB so that cylindrical drill bits can be held. For all FAMAG cylinder drill bits and auger bits, etc.</p>
	<p>Alloyed tool steel</p>		<p>With this adapter it is possible to use low-price drill bits with cylindrical shank for machines using morse cone No. 2/mafell-ZB</p>
	<p>Find recommended rpm at the corresponding tools</p>		<p>Packing unit = 1, Rose-tube</p>

1014



 Classic

Screw Auger, Lewis Pattern

FAMAG[®]
...für Besserbohrer[®]

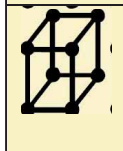
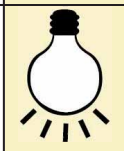
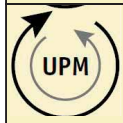
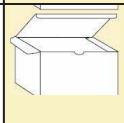

Art.- No.	O-Ø [mm]	OAL [mm]	SpL [mm]	Effective L. [mm]	€
1014.608	8	600	160	550	22,20
1014.610	10	600	160	550	22,20
1014.612	12	600	160	550	23,95
1014.614	14	600	160	550	25,15
1014.616	16	600	155	550	27,30
1014.618	18	600	150	550	30,30
1014.620	20	600	145	550	33,30
1014.622	22	600	140	550	36,60
1014.624	24	600	140	550	40,25
1014.626	26	600	140	550	44,15
1014.628	28	600	140	550	48,25
1014.630	30	600	135	550	53,20
1014.632	32	600	135	550	58,20
1014.634	34	600	145	550	73,60
1014.636	36	600	145	550	83,10
1014.638	38	600	145	550	95,00
1014.640	40	600	145	550	106,60

	<p>"Lewis" pattern, with crest of thread, one main cutting edge and one taper tap. With lug for wooden handle</p>		<p>For drilling deep holes in soft wood (depending on the diameter) and also limited in European hard wood</p>
	<p>Alloyed tool steel</p>		<p>Use beech handles. NOT included in delivery scope</p>
	<p>Depending on one's skill and strength</p>		<p>Packing unit = 1, yellow cardboard tube</p>

Technical changes or mistakes reserved! All prices are recommended retail prices additionally value added tax.

**OAL 400 mm**

Art.- No.	O-Ø [mm]	SØ [mm]	OAL [mm]	Effective L. [mm]	€
1001.408	8	6	400	370	10,45
1001.410	10	8	400	370	12,20
1001.412	12	8	400	370	15,25
1001.414	14	8	400	370	17,45
1001.416	16	10	400	370	20,05
1001.418	18	10	400	370	24,10
1001.420	20	10	400	370	31,95
1001.422	22	12	400	370	41,85
1001.424	24	12	400	370	48,75
1001.425	25	12	400	370	52,05
1001.426	26	12	400	370	53,55
1001.428	28	12	400	370	58,25
1001.430	30	12	400	370	61,60
1001.432	32	12	400	370	63,95
1001.435	35	12	400	370	70,45
1001.439	39	12	400	370	92,35

OAL 600 mm

Art.- No.	O-Ø [mm]	SØ [mm]	OAL [mm]	Effective L. [mm]	€
1001.608	8	6	600	570	11,05
1001.610	10	8	600	570	12,85
1001.612	12	8	600	570	16,00
1001.614	14	8	600	570	18,20
1001.616	16	10	600	570	21,10
1001.618	18	10	600	570	25,30
1001.620	20	10	600	570	33,00
1001.622	22	12	600	570	44,40
1001.624	24	12	600	570	51,30
1001.625	25	12	600	570	55,25
1001.626	26	12	600	570	56,15
1001.628	28	12	600	570	60,95
1001.630	30	12	600	570	64,45
1001.632	32	12	600	570	66,25
1001.635	35	12	600	570	72,45
1001.639	39	12	600	570	96,55

OAL 800 mm

Art.- No.	O-Ø [mm]	SØ [mm]	OAL [mm]	Effective L. [mm]	€
1001.808	8	6	800	770	13,30
1001.810	10	8	800	770	15,10
1001.812	12	8	800	770	18,25
1001.814	14	8	800	770	21,30
1001.816	16	10	800	770	24,85
1001.818	18	10	800	770	29,50
1001.820	20	10	800	770	37,30
1001.822	22	10	800	770	48,65

OAL 1.000 mm

Art.- No.	O-Ø [mm]	SØ [mm]	OAL [mm]	Effective L. [mm]	€
1001.108	8	6	1000	970	14,00
1001.110	10	8	1000	970	15,65
1001.112	12	8	1000	970	18,85
1001.114	14	8	1000	970	22,10
1001.116	16	10	1000	970	25,60
1001.118	18	10	1000	970	31,35
1001.120	20	10	1000	970	39,10
1001.122	22	12	1000	970	50,60
1001.124	24	12	1000	970	55,45
1001.126	26	12	1000	970	59,85
1001.128	28	12	1000	970	64,50
1001.130	30	12	1000	970	67,45

1005

 Classic

Formwork Drill Bit, SDS-Plus Shank







OAL 400mm

Art.- No.	O-Ø [mm]	Shank [mm]	OAL [mm]	Effective L. [mm]	€
1005.410	10	SDS	400	370	23,05
1005.412	12	SDS	400	370	25,85
1005.414	14	SDS	400	370	27,75
1005.416	16	SDS	400	370	31,55
1005.418	18	SDS	400	370	42,25
1005.420	20	SDS	400	370	46,05
1005.422	22	SDS	400	370	56,85
1005.424	24	SDS	400	370	64,75
1005.425	25	SDS	400	370	76,80

OAL 600mm

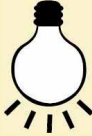
Art.- No.	O-Ø [mm]	Shank [mm]	OAL [mm]	Effective L. [mm]	€
1005.610	10	SDS	600	570	24,00
1005.612	12	SDS	600	570	26,95
1005.614	14	SDS	600	570	29,75
1005.616	16	SDS	600	570	33,00
1005.618	18	SDS	600	570	43,70
1005.620	20	SDS	600	570	47,35
1005.622	22	SDS	600	570	58,75
1005.624	24	SDS	600	570	68,80
1005.625	25	SDS	600	570	82,45
1005.626	26	SDS	600	570	87,10
1005.628	28	SDS	600	570	92,10
1005.630	30	SDS	600	570	99,90

	<p>Twist drill with long shank (SDS-plus) and specially ground roof-like tip which can be reground easily. Quality according to DIN 7490 and the valid safety regulations</p>		<p>For drilling of external and internal form boards in one single operation. Also for drilling in wooden ceilings and floors for installation work in old-building renovation</p>
	<p>Chrome vanadium steel</p>		<p>Not to be used with hammer or impact drill</p>
	<p>1200 - 2500 rpm. e.g. Ø 22 mm rpm in formwork panel</p>		<p>Packing unit = 1, PE clip</p>







OAL 400 mm

Art.- No.	O-Ø [mm]	SØ [mm]	OAL [mm]	Effective L. [mm]	€
1002.406	6	5	400	370	12,05
1002.408	8	6	400	370	11,30
1002.410	10	8	400	370	13,40
1002.412	12	8	400	370	16,75
1002.414	14	8	400	370	20,40
1002.416	16	10	400	370	25,25
1002.418	18	10	400	370	29,80
1002.420	20	10	400	370	33,85
1002.422	22	10	400	370	49,40

OAL 600 mm

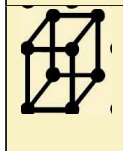
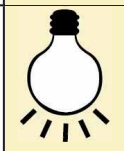
Art.- No.	O-Ø [mm]	SØ [mm]	OAL [mm]	Effective L. [mm]	€
1002.608	8	8	600	570	12,35
1002.610	10	8	600	570	14,35
1002.612	12	8	600	570	17,80
1002.614	14	8	600	570	21,45
1002.616	16	10	600	570	26,85
1002.618	18	10	600	570	31,55
1002.620	20	10	600	570	35,50

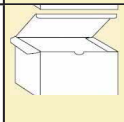
	<p>Twist drill with long shank and specially ground roof-like tip which can be reground easily. Quality according to DIN 7490 and the valid safety regulations</p>		<p>For drilling of external and internal form boards in one single operation. Also for drilling in wooden ceilings and floors for installation work in old-building renovation</p>
	<p>HSS</p>		<p>For hardest application or for drilling in metal material</p>
	<p>1600 - 3000 rpm. e.g. Ø 14 mm 2200 rpm in formwork panel</p>		<p>Packing unit = 1, PE bag</p>

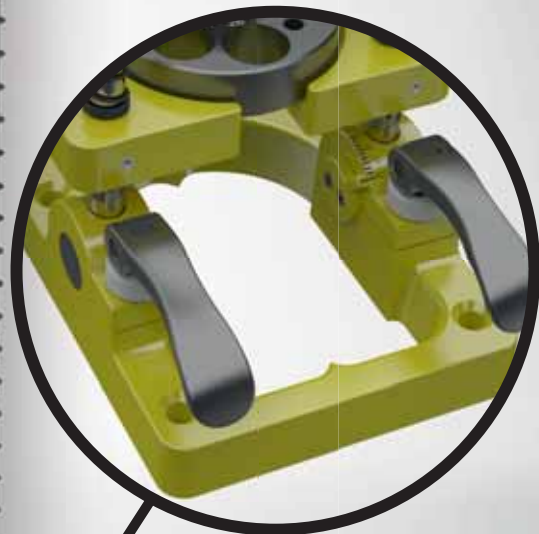
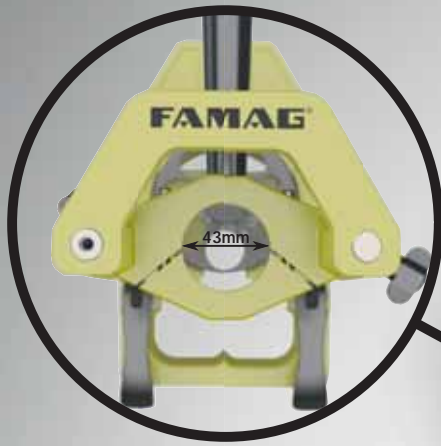







Art.- No.	For drill length [mm]	Drilling depth [mm]	Foot measure outside [mm]	Foot measure inside [mm]	OAL [mm]	€
1405.210	max. 240	210	Ø 150	Ø 90	~330	135,00
1405.320	max. 350	320	250 x 150	135 x 90	~490	200,00

Fixture

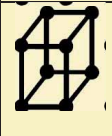
Art.- No.	Description	max. clamping width [mm]	€
1402.000	Fixture	0 - 90	69,95
1402.901	Set of Tails for broadening	200	41,30

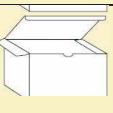
	With additional handle, two stageless adjustable depth stops. Plate for drill bush and springs are not included in scope of delivery		Precise drilling in exact 90° setting angle 1402.000: mountable on all FAMAG drill rigs with square foot
	Tool holder and foot made of cast aluminium, guide posts made of stainless steel		For power drills 43 mm
			Packing unit = 1, in carton

1403

OOOO
Excellent

Drill Rig, Fixed Version



320 mm

Art.- No.	For drill length [mm]	Drilling depth [mm]	Fixture	Drill bushing plate	Foot measure outside [mm]	Foot measure inside [mm]	OAL [mm]	€
1403.320	320	190	-	incl.	250 x 150	135 x 90	~490	280,00
1403.322	320	190	incl.	incl.	250 x 150	135 x 90	~490	350,00

460 mm

1403.460	460	310	-	incl.	250 x 150	135 x 90	~630	280,00
1403.462	460	310	incl.	incl.	250 x 150	135 x 90	~630	350,00

650 mm

1403.650	650	460	-	incl.	250 x 150	135 x 90	~810	280,00
1403.652	650	460	incl.	incl.	250 x 150	135 x 90	~810	350,00

Fixture

Art.- No.	Description	max. clamping width [mm]	€
1402.000	Fixture	0 - 90	69,95
1402.901	Set of Tails for broadening	200	41,30

	With additional handle, two stageless adjustable depth stops and two spiral springs for back stroke of the power drill. With adjustable plate for the drill bush for exact guidance of the drill bit		Precise drilling in exact 90° setting angle. Additional guidance of the drill bits by drill bushing plate. Easy back stroke of the power drill by spiral springs. 1402.000: mountable on all FAMAG drill rigs with square foot
	Tool holder and foot made of cast aluminium. Springs and guide posts made of stainless steel		For power drills 43 mm. For drill bits Ø 8, 10, 12, 14, 16, 18, 20, 22, 24, 26 mm. Version with two solid guide rods
			Packing unit = 1, in carton



320 mm

Art.- No.	For drill length [mm]	Drilling depth [mm]	Fixture	Drill bushing plate	Foot measure outside [mm]	Foot measure inside [mm]	OAL [mm]	€
1404.320	320	160	-	incl.	250 x 150	135 x 90	~490	380,00
1404.322	320	160	incl.	incl.	250 x 150	135 x 90	~490	450,00

460 mm

Art.- No.	For drill length [mm]	Drilling depth [mm]	Fixture	Drill bushing plate	Foot measure outside [mm]	Foot measure inside [mm]	OAL [mm]	€
1404.460	460	250	-	incl.	250 x 150	135 x 90	~630	380,00
1404.462	460	250	incl.	incl.	250 x 150	135 x 90	~630	450,00

650 mm

Art.- No.	For drill length [mm]	Drilling depth [mm]	Fixture	Drill bushing plate	Foot measure outside [mm]	Foot measure inside [mm]	OAL [mm]	€
1404.650	650	430	-	incl.	250 x 150	135 x 90	~810	380,00
1404.652	650	430	incl.	incl.	250 x 150	135 x 90	~810	450,00

Fixture

Art.- No.	Description	max. clamping width [mm]	€
1402.000	Fixture	0 - 90	69,95
1402.901	Set of Tails for broadening	200	41,30

	<p>With additional handle, two stageless adjustable depth stops and two spiral springs for back stroke of the power drill. With adjustable plate for drill bush for exact guidance of the drill bit.</p> <p>The product line 1406 is delivered without springs and drill bushing plate</p>		<p>Precise drilling in exact 90° to 45° stepless pivoted setting angle. Additional guidance of the drill bits by drill bushing plate. Easy back stroke of the power drill by spiral springs. 1402.000: mountable on all FAMAG drill rigs with square foot</p>
	<p>Tool holder and foot made of cast aluminium. Springs and guide posts made of stainless steel</p>		<p>For power drills 43 mm. For drill bits Ø 8, 10, 12, 14, 16, 18, 20, 22, 24, 26 mm. Version with two solid guide rods</p>
			<p>Packing unit = 1, in Carton</p>

1406

○○○○
Excellent

Drill Rig for stairs building, pivoting



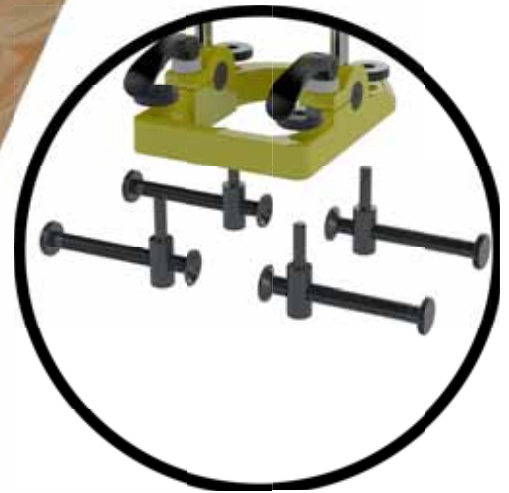

FAMAG
...für Besserbohrer®



Art.- No.	For drill length [mm]	Drilling depth [mm]	Fixture	Foot measure outside [mm]	Foot measure inside [mm]	OAL [mm]	€
1406.320	max. 350	320	-	200 x 150	155 x 100	~490	280,00
1406.322	max. 350	320	incl.	200 x 150	155 x 100	~490	350,00



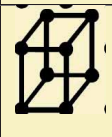

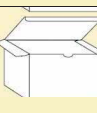
Fixture

Art.- No.	Description	max. clamping width [mm]	€
1402.000	Fixture	0 - 90	69,95
1402.901	Set of Tails for broadening	200	41,30

	With additional handle, stageless adjustable depth stop and pivoting range up to 45°. Easy setting by clamping lever		For power drills 43 mm. Precise drilling in exact 90 -45° setting angle, especially suitable for the construction of stairs. 1402.000: mountable on all FAMAG drill rigs with square foot
	Tool holder and foot made of cast aluminium. Guide posts made of stainless steel		Due to the pivoting fixture also applicable for curved cheeks. For staircase > 45° please use a shim
			Packing unit = carton

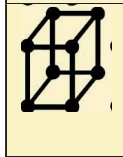
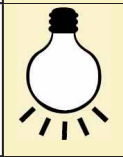

Art.- No.	O-Ø [mm]	SØ [mm]	OAL [mm]	SpL [mm]	CPL [mm]	€
1575.010	10	13	160	85	11	60,45
1575.012	12	13	170	100	12	60,45
1575.013	13	13	180	110	13	63,35
1575.014	14	13	180	105	13	63,35
1575.015	15	13	185	120	14	70,00
1575.016	16	13	190	120	14	70,00
1575.018	18	13	200	130	15	76,50
1575.020	20	13	210	135	16	86,70
1575.022	22	13	220	140	18	118,90
1575.024	24	13	240	160	19	148,15
1575.025	25	13	240	170	19	166,45
1575.026	26	13	240	160	20	183,95
1575.028	28	13	260	180	21	197,10
1575.030	30	13	270	180	23	216,20

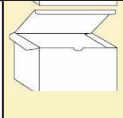
	<p>Brad point drill bit with extra long brad point (ground three-edged), two main cutting edges, two taper taps, four grooves on the spiral</p>		<p>For drilling paling fences in stringers or handrails of staircases. Only limitedly recommended for hard wood</p>
	<p>Tool alloyed steel</p>		<p>Better results with the three-edged than the four-edged brad point. As alternative item we offer the Bormax 1624. For hard wood we recommend the TCT-Bormax³ prima 1664 combined with a drill rig</p>
	<p>800 - 2500 rpm e.g. Ø 16 mm 2000 rpm in soft wood</p>		<p>Packing unit = 1, Rose-tube</p>

1594

○○○○
Excellent

Brad Point Drill Bit, HSS-G

FAMAG[®]
...für Besserbohrer[®]



Art.- No.	O-Ø [mm]	SØ [mm]	OAL [mm]	Effective L. [mm]	€
1594.020	2,0	2,0	49	22	7,20
1594.025	2,5	2,5	57	25	7,20
1594.030	3,0	3,0	60	33	5,75
1594.035	3,5	3,5	70	39	6,20
1594.040	4,0	4,0	75	43	6,20
1594.045	4,5	4,5	80	47	6,55
1594.050	5,0	5,0	85	52	6,55
1594.055	5,5	5,5	92	57	6,85
1594.060	6,0	6,0	92	57	6,85
1594.065	6,5	6,5	100	63	8,05
1594.070	7,0	7,0	108	69	8,40
1594.075	7,5	7,5	108	69	9,60
1594.080	8,0	8,0	115	75	9,25
1594.085	8,5	8,5	115	75	10,30
1594.090	9,0	9,0	125	81	11,25
1594.095	9,5	9,5	125	81	12,55
1594.100	10,0	10,0	130	87	12,80
1594.105	10,5	10,5	130	87	18,15
1594.110	11,0	11,0	140	94	16,60
1594.115	11,5	11,5	140	94	21,30
1594.120	12,0	12,0	150	101	19,80
1594.125	12,5	12,5	150	101	24,05
1594.130	13,0	13,0	150	101	21,30
1594.135	13,5	13,0	160	108	30,90
1594.140	14,0	13,0	160	108	32,00
1594.145	14,5	13,0	168	114	35,45
1594.150	15,0	13,0	168	114	37,70
1594.155	15,5	13,0	176	120	41,20
1594.160	16,0	13,0	176	120	42,30
1594.162	16,2	13,0	200	140	48,00
1594.165	16,5	13,0	180	120	48,00
1594.180	18,0	13,0	190	130	53,05
1594.190	19,0	13,0	192	132	62,30
1594.200	20,0	13,0	200	140	66,70

For bigger diameters we recommend product line 1599.2 on page 48

Sets

Art.- No.	Description	€
1594.835	5 pcs. Set in plastic box Ø 3, 4, 5, 6, 8 mm	30,95
1594.845	5 pcs. Set in plastic box Ø 4, 5, 6, 8, 10 mm	40,60
3575.505	6 pcs. Set in wooden case, brad point drill bit HSS, type 1594 Ø 3, 4, 5, 6, 8 mm incl. VARIO Countersink 2202 (90°)	63,10
1594.507	7 pcs. Set in wooden case Ø 3, 4, 5, 6, 8, 10, 12 mm	69,85
1594.838	8 pcs. Set in plastic box Ø 3, 4, 5, 6, 7, 8, 9, 10 mm	60,15
1594.510	10 pcs. Set in wooden case Ø 3, 4, 5, 6, 8, 10, 12, 13, 14, 16 mm	161,30
1594.819	19 pcs. in Rose plastic box Ø 1 - 10 mm, 0,5 mm steps	131,90
1594.825	25 pcs. in Rose plastic-box Ø 1 - 13 mm, 0,5 mm steps	234,55







	<p>Premium version, fully ground quality with two main cutting edges and two taper taps. Specially ground spiral for a very good chip removal</p>		<p>For exact drilling in all, particularly hard materials. Also suitable for some plastics, like acrylic glass, Corian®, GFRP, HPL coating, polycarbonate, PVC and Trespa® board. Specially designed flutes ensure a very good chip removal</p>
	<p>HSS-G</p>		<p>Premium quality at a fair price. Specially suitable for stationary use. For soft wood the cordless drill is only limited applicable, due to the low rotation speed. Here we recommend product lines 1591 with cylindrical shank or 1596/1597 with hexagonal shank</p>
	<p>2400 - 8000 rpm e.g. Ø 4 mm 5000 rpm in European hard wood. Further details in the speed diagram</p>		<p>Packing unit = 1, Rose-tube</p>

Technical changes or mistakes reserved! All prices are recommended retail prices additionally value added tax.

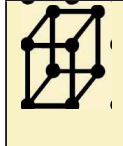

Art.- No.	O-Ø [mm]	SØ [mm]	OAL [mm]	Effective L. [mm]	€
1595.020	2,0	2,0	49	22	12,90
1595.025	2,5	2,5	57	25	12,90
1595.030	3,0	3,0	60	33	10,85
1595.035	3,5	3,5	70	39	11,60
1595.040	4,0	4,0	75	43	11,60
1595.045	4,5	4,5	80	47	12,35
1595.050	5,0	5,0	85	52	12,35
1595.060	6,0	6,0	92	57	13,10
1595.070	7,0	7,0	108	69	15,00
1595.080	8,0	8,0	115	75	16,15
1595.090	9,0	9,0	125	81	20,15
1595.100	10,0	10,0	130	87	21,70

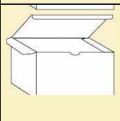
	<p>Premium version, left hand cutting, fully ground quality with two main cutting edges and two taper taps. Internally ground special spiral for very good chip removal</p>		<p>For exact drilling in all, particularly hard materials. Also suitable for some plastics, like acrylic glass, Corian®, GFRP, HPL coating, polycarbonate, PVC and Trespa® board. Shank constructed for drill chuck Ø 13 mm. Left hand cut</p>
	<p>HSS-G</p>		<p>Premium quality at a fair price. Specially designed chip flutes guarantee a good chip removal</p>
	<p>3000 - 8000 rpm e.g. Ø 5 mm 4500 rpm in European hard wood. Further details in the speed diagram</p>		<p>Packing unit = 1, Rose-tube</p>

1599

 Excellent

Brad Point Drill Bit, HSS-G, Extra Long

FAMAG[®]
 ...für Besserbohrer[®]

OAL 150 mm

Art.- No.	O-Ø [mm]	SØ [mm]	OAL [mm]	Effective L. [mm]	€
1599.103	3	3	150	100	12,40
1599.104	4	4	150	100	12,40
1599.105	5	5	150	100	13,10
1599.106	6	6	150	100	13,90
1599.107	7	7	150	100	18,05
1599.108	8	8	150	100	18,05
1599.109	9	9	150	100	19,15
1599.110	10	10	150	100	20,95
1599.111	11	11	150	100	23,70

For bigger diameters we recommend product line 1594 on page 46

OAL 250 mm

Art.- No.	O-Ø [mm]	SØ [mm]	OAL [mm]	Effective L. [mm]	€
1599.203	3	3	250	200	17,85
1599.204	4	4	250	200	17,85
1599.205	5	5	250	200	20,35
1599.206	6	6	250	200	22,80
1599.207	7	7	250	200	29,40
1599.208	8	8	250	200	29,40
1599.209	9	9	250	200	32,80
1599.210	10	10	250	200	35,70
1599.211	11	11	250	200	41,15
1599.212	12	12	250	200	45,30
1599.213	13	13	250	200	48,10
1599.214	14	13	250	200	52,05
1599.215	15	13	250	200	59,75
1599.216	16	13	250	200	65,85
1599.218	18	13	250	200	97,30
1599.220	20	13	250	200	123,55
1599.222	22	13	250	200	150,30
1599.224	24	13	250	200	179,85
1599.225	25	13	250	200	196,85

OAL 315 mm

Art.- No.	O-Ø [mm]	SØ [mm]	OAL [mm]	Effective L. [mm]	€
1599.303	3	3	315	250	23,25
1599.304	4	4	315	250	23,25
1599.305	5	5	315	250	26,50
1599.306	6	6	315	250	29,65
1599.307	7	7	315	250	38,25
1599.308	8	8	315	250	38,25
1599.309	9	9	315	250	42,60
1599.310	10	10	315	250	46,45
1599.311	11	11	315	250	53,40
1599.312	12	12	315	250	58,95
1599.313	13	13	315	250	62,50
1599.314	14	13	315	250	68,80
1599.315	15	13	315	250	80,05
1599.316	16	13	315	250	93,25

OAL 400/ 460 mm





Art.- No.	Description	O-Ø [mm]	SØ [mm]	OAL [mm]	Effective L. [mm]	€
1599.403	End Of Series	3	3	400	300	30,20
1599.404	End Of Series	4	4	400	300	30,20
1599.405	End Of Series	5	5	400	300	34,40
1599.406	End Of Series	6	6	400	300	38,50
1599.407	End Of Series	7	7	400	300	49,60
1599.408	End Of Series	8	8	400	300	49,60
1599.409	End Of Series	9	9	400	300	55,40
1599.410	End Of Series	10	10	400	300	60,30
1599.411	End Of Series	11	11	400	300	69,30
1599.412	End Of Series	12	12	400	300	76,60
1599.413	End Of Series	13	13	400	300	81,20
1599.414	End Of Series	14	13	400	300	89,40
1599.415	End Of Series	15	13	400	300	104,00
1599.416	End Of Series	16	13	400	300	121,10

OAL 460 mm

Art.- No.	O-Ø [mm]	SØ [mm]	OAL [mm]	Effective L. [mm]	€
1599.603	3	3	460	380	39,55
1599.604	4	4	460	380	39,55
1599.605	5	5	460	380	44,80
1599.606	6	6	460	380	49,25
1599.607	7	7	460	380	63,90
1599.608	8	8	460	380	63,90
1599.609	9	9	460	380	73,90
1599.610	10	10	460	380	73,90
1599.611	11	11	460	380	84,75
1599.612	12	12	460	380	90,90
1599.613	13	13	460	380	99,65
1599.614	14	13	460	380	108,65
1599.615	15	13	460	380	128,80
1599.616	16	13	460	380	146,25

Sets

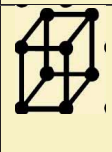
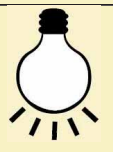
Art.- No.	Description	€
1599.507	7 pcs. Set in wooden case: OAL 250 mm, EL 200 mm, Ø 3, 4, 5, 6, 7, 8, 9, 10, 11, 12 mm	167,55
1599.510	10 pcs. Set in wooden case: OAL 150 mm, NL 100 mm, Ø 3, 4, 5, 6, 8, 10, 12 mm	149,90

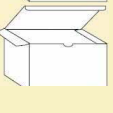
	Premium quality version, extra long, fully ground quality with two main cutting edges and two taper taps. Internally ground special spiral for very good chip removal		For exact drilling in all, particularly hard materials. Also suitable for some plastics, such as acrylic glass, Corian®, GFRP, HPL coating, polycarbonate, PVC and Trespa® board. Specially designed chip flutes guarantee a good chip removal, you receive best results when drilling deep holes
	HSS-G		Please do not use drills with a smaller Ø than 8 mm in the power drill, it might break. Premium quality at a fair price. Optionally put the brad point on the surface
	2500 - 4000 rpm e.g. Ø 5 mm 4000 rpm in European hard wood. Smaller Ø with long OAL should be used with less speed		Packing unit = 1, Rose-tube

1591

 Classic





Brad Point Drill Bit, HSS

FAMAG®
 ...für Besserbohrer®

Art.- No.	O-Ø [mm]	SØ [mm]	OAL [mm]	Effective L. [mm]	€
1591.030	3	3	61	33	4,55
1591.040	4	4	75	43	4,65
1591.050	5	5	86	52	4,95
1591.060	6	6	93	57	5,15
1591.070	7	7	109	69	5,75
1591.080	8	8	117	75	6,00
1591.090	9	9	125	80	6,70
1591.100	10	10	133	87	7,05
1591.110	11	10	142	89	8,80
1591.120	12	10	151	96	10,65
1591.130	13	10	151	96	12,30
1591.140	14	10	151	96	15,00
1591.150	15	10	160	100	17,35
1591.160	16	10	160	100	20,00
1591.180	18	10	180	130	28,80
1591.200	20	10	200	140	33,75

Sets

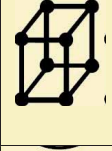
Art.- No.	Description	€
1591.835	5 pcs. Set in plastic box Ø 3, 4, 5, 6, 8 mm	22,65
1591.845	5 pcs. Set in plastic box Ø 4, 5, 6, 8, 10 mm	24,60
1591.507	7 pcs. Set in wooden case Ø 3, 4, 5, 6, 8, 10, 12 mm	41,25
1591.838	8 pcs. Set in plastic box Ø 3, 4, 5, 6, 7, 8, 9, 10 mm	40,20
1591.511	11 pcs. Set in wooden case Ø 3, 4, 5, 6, 8, 10, 12, 13, 14, 15, 16 mm	103,20

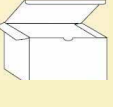
	With brad point, two main cutting edges and two taper taps. Cylindrical shank up to Ø 10 mm, ≥ Ø 10 mm with shank-Ø 10 mm.		For accurate drillings in soft wood, European hard wood, chipboards as well as MDF panels. Ideal use with cordless screwdriver in soft wood
	HSS		The cost-effective brad point drill bit. For higher demands we recommend our product line 1594 in HSS-G with taper taps
	2400-8000 rpm e.g. Ø 4 mm 5000 rpm in European hard wood. Further details in the speed diagram		Packing unit = 1, Rose tube

1593

 Profi





Brad Point Drill Bit, TCT

FAMAG
...für Besserbohrer

Art.- No.	O-Ø [mm]	SØ [mm]	OAL [mm]	Effective L. [mm]	€
1593.030	3	3	58	30	18,00
1593.040	4	4	72	40	18,00
1593.050	5	5	83	49	18,70
1593.060	6	6	90	54	20,10
1593.070	7	7	106	66	22,00
1593.080	8	8	114	72	22,00
1593.090	9	9	122	78	27,70
1593.100	10	10	130	84	27,70
1593.110	11	11	139	91	31,15
1593.120	12	12	148	98	31,15

Sets

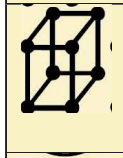
Art.- No.	Description	€
1593.845	5 pcs. Set in plastic box Ø 4, 5, 6, 8, 10 mm	95,80
3575.507	6 pcs. Set in wooden case, brad point drill bit TCT, type 1593 Ø 3, 4, 5, 6, 8 mm incl. VARIO Countersink 2202 (90°)	119,00
1593.507	7 pcs. Set in wooden case Ø 3, 4, 5, 6, 8, 10, 12 mm	139,90
1593.510	10 pcs. Set in wooden case Ø 3, 4, 5, 6, 7, 8, 9, 10, 11, 12 mm	212,55

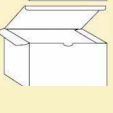
	TCT brad point drill bit, cylindrical, two main cutting edges, two taper taps. Spiral form N		For dimensionally stable and clean drilling in hard wood (European and exotic), laminated and untreated chipboards and plastics like acrylic glass, Corian, GFRP, HPL coating, polycarbonate, PVC and Trespa board
	TCT (main cutting edges and taper taps)		Professional tool with highest service life at a fair price. Ideal for freehand drilling as well as stationary use. Boring and countersinking in one step in combination with countersink VARIO 2202
	4.000 - 10.000 rpm e.g. Ø 5 mm 8.000 rpm in European hard wood. Further details in the speed diagram		Packing unit = 1, Rose-tube

Technical changes or mistakes reserved! All prices are recommended retail prices additionally value added tax.

3500

Hobby

Brad Point Drill Bit, CV



Art.- No.	O-Ø [mm]	SØ [mm]	OAL [mm]	Effective L. [mm]	€
3500.030	3	3	61	33	2,50
3500.040	4	4	75	43	2,80
3500.050	5	5	86	52	3,05
3500.060	6	6	93	57	3,15
3500.070	7	7	109	69	3,30
3500.080	8	8	117	75	3,65
3500.090	9	9	120	80	4,20
3500.100	10	10	129	87	4,35
3500.110	11	10	142	89	5,50
3500.120	12	10	151	96	5,85
3500.130	13	10	151	96	6,90
3500.140	14	10	151	96	7,30
3500.150	15	10	160	100	8,05
3500.160	16	10	160	100	8,55
3500.180	18	10	180	130	15,10
3500.200	20	10	200	140	20,05
3500.220	22	13	210	140	22,00
3500.240	24	13	215	140	24,25
3500.250	25	13	215	140	26,50
3500.260	26	13	215	145	26,50
3500.280	28	13	220	145	28,35
3500.300	30	13	220	145	30,90

Sets





Art.- No.	Description	€
3501.505	5 pcs. Set in plastic box. Ø 4, 5, 6, 8, 10 mm	11,75
3501.508	8 pcs. Set in plastic box. Ø 3, 4, 5, 6, 7, 8, 9, 10 mm	17,05
3500.515	15 pcs. Set in wooden case Ø 3, 4, 5, 6, 8, 10 mm with each one depth adjusting collar and 16 mm HSS machine countersink	53,35

	With brad point, two main cutting edges and protruding cutting edges		For exact drilling in soft wood and some European hard wood
	Chrome vanadium steel		The low-cost machine drill . For higher demands we recommend our product line 1594 HSS-G
	1000 - 5000 rpm e.g. Ø 5 mm 5000 rpm in softwood. Further details in the speed diagram		Packing unit = 1, PE pouch

Technical changes or mistakes reserved! All prices are recommended retail prices additionally value added tax.

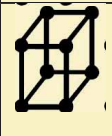

Art.- No.	O-Ø [mm]	SØ [mm]	OAL [mm]	Effective L. [mm]	€
3491.006	6	6	250	190	8,55
3491.008	8	8	250	190	9,10
3491.010	10	10	250	190	10,95
3491.012	12	10	250	190	13,00
3491.014	14	10	250	190	15,70
3491.016	16	10	250	190	18,70
3491.018	18	10	250	190	21,30
3491.020	20	10	250	190	22,95

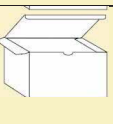
	With brad point, two main edges and protruding cutting edges		For exact drilling in soft wood and some European hard wood
	Chrome Vanadium steel		The low-cost long brad point drill bit. For high demands we recommend our product line 1594 HSS-G
	1500 - 4000 rpm e.g. Ø 5 mm 4000 rpm in soft wood. Further details in the speed diagram		Packing unit = 1, Rose-tube

2108

 Classic

Depth Adjusting Collars

FAMAG[®]
...für Besserbohrer[®]







Art.- No.	Description	∅ [mm]	O-∅ [mm]	€
2108.003	PU = 1 (contains 10 pcs.)	3	7	15,80
2108.004	PU = 1 (contains 10 pcs.)	4	8	15,80
2108.005	PU = 1 (contains 10 pcs.)	5	10	15,05
2108.006	PU = 1 (contains 10 pcs.)	6	12	15,05
2108.007	PU = 1 (contains 10 pcs.)	7	12	15,05
2108.008	PU = 1 (contains 10 pcs.)	8	16	15,80
2108.009	PU = 1 (contains 10 pcs.)	9	18	17,40
2108.010	PU = 1 (contains 10 pcs.)	10	20	18,05
2108.011	PU = 1 (contains 10 pcs.)	11	20	19,60
2108.012	PU = 1 (contains 10 pcs.)	12	22	20,40

Sets

Art.- No.	Description	€
2108.505	5 pcs. Set in plastic tube ∅ 4, 5, 6, 8, 10 mm	7,25
2108.507	7 pcs. Set in plastic tube ∅ 3, 4, 5, 6, 8, 10, 12 mm	10,45

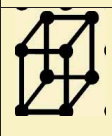
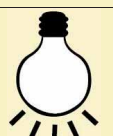
Single depth adjusting collar for countersinks with ∅ 16 mm

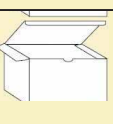
Art.- No.	Description	∅ [mm]	OAL [mm]	€
2108.216	depth adjusting collar for countersinks type 2100: 3 - 7 mm	16	20	5,55

	Clamp collar to be mounted on drill bits, with lateral attachment screw		For fixing on drill bits to adjust the drilling depth
	Tool steel		If you don't need 10 pcs. of one size, we recommend product line 2108.505 und 2108.507
	∅ 3 and 4 mm drill bits with assembled ring should be used with lower rpm than the recommended speed for the single drill bit		PU = 1 (10 pcs in Rose tube), 2108.216 and sets PU = 1, SB packaging in Rose tube

1598

 Excellent





Right-Angle-Driver 90fix

FAMAG
...für Besserbohrer

Art.-No.	Bit [mm]	Angle	Height [mm]	€
1598.750	6,3	90°	40	59,95

Sets

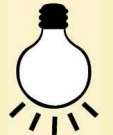
Art.-No.	Description	€
1598.757	90fix set, for woodworking, in wooden case	88,55
1598.758	90fix set, for metalworking, in wooden case	88,55
1598.612	90fix set 13 pcs, for woodworking, in pouch	116,15

	Solid right-angle-driver with aluminium housing and bevel toothed metal gear wheels (ideal transmission of force). Take-up device for all 1/4" bits and drilling tools (e.g. product line 1596) with hexagonal shank. Angle of screwing 90°, exchangeable plastic handle		Professional screwing and drilling "to the last corner" with cordless screwdriver. Maximum transferable torque 50Nm
	aluminium housing		Ideal for screwings with a cordless screwdriver in a small space. Works well in combination with product lines 1596/2596
	Rotation speed of cordless screwdriver max 2000 rpm		Packing unit = 1, Blister pack

Technical changes or mistakes reserved! All prices are recommended retail prices additionally value added tax.

1596

 Profi





Brad Point Drill Bit, HSS-G

FAMAG
 ...für Besserbohrer®

Art.- No.	O-Ø [mm]	Shank [mm]	OAL [mm]	Effective L. [mm]	€
1596.030	3	C 6,3	38	16	7,10
1596.035	3,5	C 6,3	40	18	7,10
1596.040	4	C 6,3	44	20	7,10
1596.045	4,5	C 6,3	46	24	7,30
1596.050	5	C 6,3	50	26	7,30
1596.055	5,5	C 6,3	50	26	7,80
1596.060	6	C 6,3	50	26	7,80
1596.065	6,5	C 6,3	50	30	7,80
1596.070	7	C 6,3	50	30	7,80
1596.075	7,5	C 6,3	51	32	9,80
1596.080	8	C 6,3	51	32	9,80
1596.085	8,5	C 6,3	53	33	10,60
1596.090	9	C 6,3	53	33	12,00
1596.100	10	C 6,3	54	38	12,00

Sets

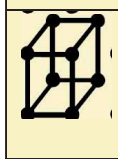
Art.- No.	Description	€
1596.508	9 pcs. Set in wooden case Ø 3, 4, 5, 6, 7, 8, 9, 10 mm and bitholder	66,85
1596.805	5 pcs. Set in blister pack Ø 3, 4, 5, 6, 8 mm	34,90

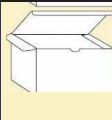



	One-piece drill bit (C6,3) with brad point, two main cutting edges, two protruding cutting edges and a hexagonal shank for bit holder (1/4"; C 6,3)		For pre-drilling and lightning-fast tool change to screw bit, drilling in all wooden materials and many plastics
	HSS-G		Good handling with cordless screwdriver. The specially smooth chip flutes enable a good chip removal. Also available as twist drill product line 2596, see twist drills and countersinks
	Maximum rotation speed of the cordless screwdriver: recommended 3000 rpm		Packing unit = 1, Rose-tube



Art.- No.	O-Ø [mm]	Shank [mm]	OAL [mm]	Effective L. [mm]	€
1597.030	3	C 6,3	70	45	8,40
1597.035	3,5	C 6,3	70	45	8,40
1597.040	4	C 6,3	75	50	8,20
1597.045	4,5	C 6,3	80	55	8,20
1597.050	5	C 6,3	86	61	8,10
1597.055	5,5	C 6,3	93	68	7,85
1597.060	6	C 6,3	93	68	7,85
1597.065	6,5	C 6,3	101	76	7,80
1597.070	7	C 6,3	109	84	8,45
1597.075	7,5	C 6,3	109	84	9,80
1597.080	8	C 6,3	117	92	9,80
1597.085	8,5	C 6,3	117	92	10,60
1597.090	9	C 6,3	125	100	12,00
1597.100	10	C 6,3	133	108	12,00
1597.110	11	C 6,3	142	117	15,15
1597.120	12	C 6,3	151	126	16,60
1597.130	13	C 6,3	151	126	17,80

Sets

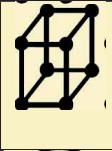
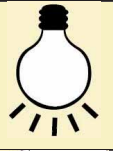
Art.- No.	Description	€
1597.805	5 pcs. Set in PVC-Box Ø 3, 4, 5, 6 and 8 mm	37,85
1597.507	7 pcs. Set in wooden case Ø 3, 4, 5, 6, 8, 10, 12 mm	58,60
1597.511	11 pcs. Set in wooden case Ø 3, 4, 5, 6, 7, 8, 9, 10, 11, 12, 13 mm	111,05

	One-piece drill bit (C6,3) with brad point, two main cutting edges, two protruding cutting edges and a hexagonal shank for bit holder (1/4"; C 6,3)		For pre-drilling and lightning-fast tool change to screw bit, drilling in all wooden materials and lot of plastics
	HSS-G		Good handling with cordless screwdriver. The specially smooth chip flutes enable a good chip removal. Also available as twist drill product line 2597, see twist drills and countersinks
	Maximum rotation speed of the cordless screwdriver: recommended 3000 rpm		Packing unit = 1, Rose-tube

1886

Profi

Step Drill Bit, HSS

FAMAG
...für Besserbohrer®



Art.- No.	Description	Ø1 [mm]	L 1 [mm]	Ø2 [mm]	L 2 [mm]	Ø3 [mm]	L 3 [mm]	SØ [mm]	Shank length [mm]	€
1886.050	with depth stop	5	36	7	20	10	20	8	25	51,00
1886.150	without depth stop	5	36	7	20	10	20	8	25	49,15

	Three-step machine drill bit with brad point and protruding cutting edges		For pre-drilling and countersinking holes in one single operation
	HSS		Can be upgraded with the depth adjusting collar product line 2108
	Ø 5 mm 5000 rpm in chipboard. Use with less speed in laminated material		Packing unit = 1, Rose-tube

1880

Profi

Drill for Spyhole

FAMAG
...für Besserbohrer®

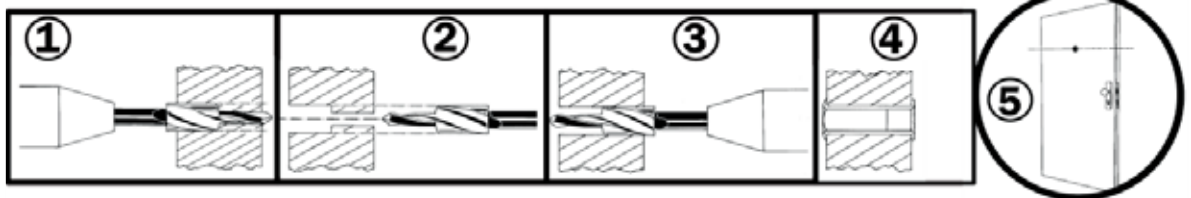

Art.- No.	Door [Ø]	Ø1 [mm]	L 1 [mm]	Ø2 [mm]	L 2 [mm]	Stem Ø [mm]	SØ [mm]	€
1880.001	12 mm	8	25	13	25	10	10	52,25
1880.002	14 mm	8	25	15	25	10	10	55,35

	Two-step drill bit. Pre-drill bit with point angle, core drill with two taper taps		For drilling tear free and exact holes for inserting a spyhole. Details according to the drawing
	Alloyed tool steel		If the door leaf has an aluminium core, best results are achieved with the step drill HSS, product line 3692
	For free hand application use the maximum rpm of the cordless screwdriver. Further details in the speed diagram		Packing unit = 1, Rose-tube



Version A

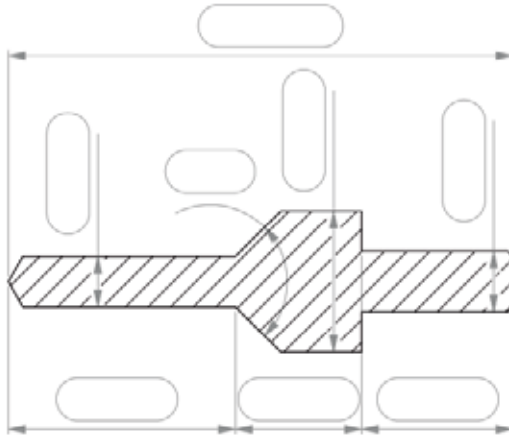

HSS WS/ tool steel
Menge/ Qty.

Version B

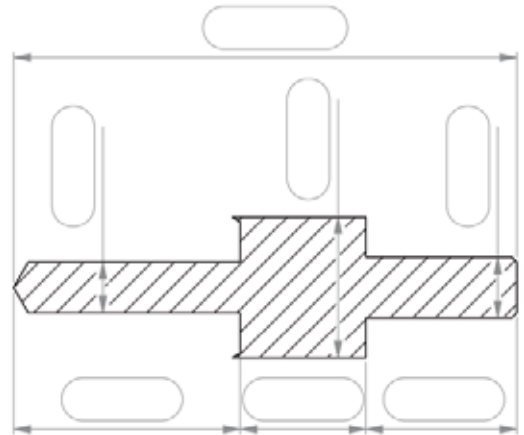

HSS WS/ tool steel
Menge/ Qty.

Version C

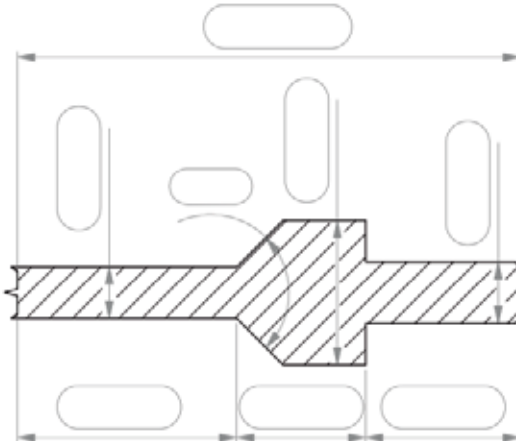

HSS WS/ tool steel
Menge/ Qty.

Version D

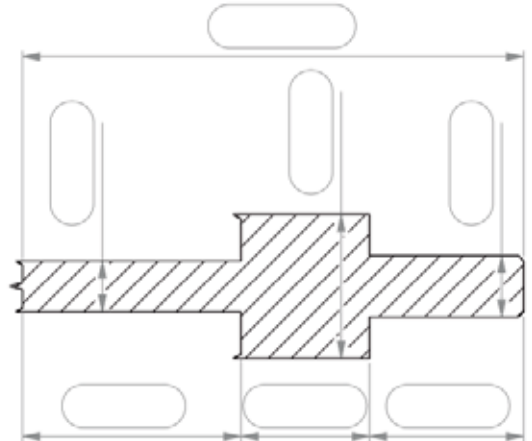

HSS WS/ tool steel
Menge/ Qty.

	<p>Two or more-step spiral drill bit with a fixed countersink. Version A and B with ground surface of a cone, version C and D with brad point and protruding cutting edges</p>		<p>Drilling and countersinking (90° or 180°) in soft wood, European hard wood and shipboard as well as MDF. Production according to drawing respectively indication of the desired sizes and design</p>
	<p>HSS / alloyed tool steel</p>		<p>Depending on the quantity, you have to schedule a delivery time of 4 - 6 weeks. Please use the parameters shown above for your inquiry and do not forget to mention the quantity</p>
	<p>1500 - 4000 rpm. e.g. sink-Ø 25 mm 2000 rpm in European hard wood. Further details in the speed diagram</p>		<p>Packing unit = 1, Rose-tube</p>

1775

Profi

Countersink, with Pointed Angle 90°, HSS



Art.-No.	O-Ø [mm]	SØ [mm]	OAL [mm]	Effective L. [mm]	€
1775.010	10	8	90	60	15,55
1775.013	13	8	90	60	16,75
1775.016	16	8	90	60	17,40
1775.020	20	8	90	60	19,45
1775.025	25	8	90	60	23,50
1775.030	30	8	90	60	27,75

Sets

Art.-No.	Description	€
1775.505	5 pcs. Set in wooden case Ø 10, 13, 16, 20, 25 mm	83,20

	<p>Seven-edged countersink with pointed angle 90°, irregular pitch, with fully ground tool head for finest results</p>		<p>Countersinking in all sorts of wood, also suitable for veneered, laminated panels and many plastics like acrylic glass, Corian®, GFRP, HPL coating, polycarbonate, PVC and Trespa® board</p>
	<p>HSS</p>		<p>Due to the specially designed pitch, it is possible to countersink without chattering also in soft wood. For all non-ferrous metals, hard plastics etc., we recommend the carbide tipped adjustable countersink VARIO 2202 or the countersinks of the product line 3540</p>
	<p>1000 - 2500 rpm. e.g. Ø 16 mm 1800 rpm in soft wood. Further details in the speed diagram</p>		<p>Packing unit = 1, Rose-tube</p>

Technical changes or mistakes reserved! All prices are recommended retail prices additionally value added tax.







2115

 Profi

Cross-Hole Countersink

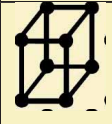
FAMAG
...für Besserbohrer

Art.- No.	O-Ø [mm]	SØ [mm]	OAL [mm]	Effective L. [mm]	€
2115.013	13	8	80	50	20,35
2115.016	16	8	90	60	23,35
2115.020	20	8	90	60	27,35

	One-edged countersink with bored hole and countersinking angle of 90°		Countersinking in all sorts of wood, also suitable for veneered, laminated panels (for plastic laminated panels we recommend product line VARIO 2202)
	Alloyed tool steel		Thanks to the geometry of the tool head, a good guidance and countersinking without chattering is possible. For bigger countersinking series we recommend product line countersink 1775
	600 - 1000 rpm. e.g. Ø 16 mm 800 rpm in soft wood		Packing unit = 1, Rose-tube





3532

 Hobby

Countersink

FAMAG
...für Besserbohrer

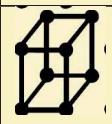
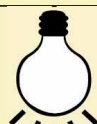
Art.- No.	O-Ø [mm]	SØ [mm]	OAL [mm]	€
3532.010	10	E 6,3	50	4,15
3532.012	12	E 6,3	50	4,35
3532.014	14	E 6,3	50	4,45
3532.016	16	E 6,3	50	4,50
3532.020	20	E 6,3	50	5,05

	Countersink with five edges, point angle 90° and bit shank E 6,3		Countersinking in soft wood, also suitable for veneered panels (for plastic laminated panels we recommend product line VARIO 2202). The low-price countersink for DIY clientele
	Alloyed tool steel		For hard plastics etc. we recommend the carbide tipped VARIO 2202 or the version 3540
	500 - 2500 rpm. e.g. Ø 12 mm 2000 rpm in soft wood. Further details in the speed diagram		Packing unit = 1, Rose-tube

Technical changes or mistakes reserved! All prices are recommended retail prices additionally value added tax.

2100

 Classic







Countersink

FAMAG
 ...für Besserbohrer®

Art. No.	∅ [mm]	O-∅ [mm]	OAL [mm]	€
2100.030	3,0	16	25	13,05
2100.035	3,5	16	25	13,05
2100.040	4,0	16	25	13,05
2100.045	4,5	16	25	13,05
2100.050	5,0	16	25	13,05
2100.055	5,5	16	25	13,05
2100.060	6,0	16	25	13,05
2100.065	6,5	16	25	16,25
2100.070	7,0	16	25	16,25
2100.080	8,0	20	25	16,25
2100.100	10,0	20	25	16,25

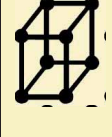
Accessory

Art. No.	Description	€
2108.216	depth adjusting collar for countersinks type 2100: 3 - 7 mm	5,55

	Countersink with five edges and point angle 90°, to be clipped on drill bits, incl. allen key, without drill bit		Drilling and countersinking in one single operation. For clipping on drill bits with the appropriate ∅. Very suitable for soft wood and veneered panels, for European hard wood only limited applicable
	Alloyed tool steel		Countersinking of screw heads and drilling in soft wood at the same time. We recommend the use of our drill bit product lines 3500 or 1591. For higher demands we recommend product line 1594 (HSS-G) with VARIO 2202
	1500 - 2200 rpm. e.g. all countersinks with A-∅ 16 mm 1500 rpm in soft wood		Packing unit = 1, Rose-tube





3537

 Hobby

Countersink

FAMAG
 ...für Besserbohrer®

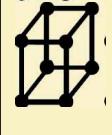
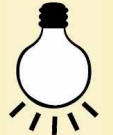
Art. No.	∅ [mm]	O-∅ [mm]	OAL [mm]	€
3537.003	3	12	20	6,85
3537.004	4	12	20	6,85
3537.005	5	12	20	6,85
3537.006	6	12	20	6,85

	Countersink with five edges and point angle 90° to be clipped on drill bits. For DIY clientele. Without allen key		Drilling and countersinking in one single operation. For clipping on drill bits with the appropriate ∅. Very suitable for soft wood
	Alloyed tool steel		Countersinking of screw heads and drilling in soft wood at the same time. We recommend the use of our drill bit product lines 3500 or 1590. For higher demands we recommend our product line 2100 with VARIO 2202
	2000 - 2200 rpm. e.g. all countersinks with A-∅ 12 mm 2000 rpm in soft wood. Further details in the speed diagram		Packing unit = 1, Rose-tube

3573

 Classic

Drill Bit - Countersink Set

FAMAG®
...für Besserbohrer®







Art. No.	lØ [mm]	O-Ø [mm]	OAL [mm]	Effective L. [mm]	€
3573.030	3	16	60	15	13,95
3573.040	4	16	75	30	13,95
3573.050	5	16	85	40	13,95
3573.060	6	16	95	50	13,95
3573.080	8	20	115	70	15,10
3573.100	10	20	130	85	15,70

Accessory

Art. No.	Description	€
2108.216	depth adjusting collar for countersinks type 2100: 3 - 7 mm	5,55

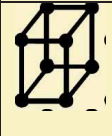
Sets

Art. No.	Description	€
3574.504	5 pcs. Set in wooden case. Drill bits 3500 Ø 3, 4, 5, 6 mm with countersinks 2100, assembled, + depth adjusting collar	53,30

	Brad point drill bit, our product line 3500 (CV), with assembled countersink product line 2100 (alloyed tool steel), incl. allen key		Drilling and countersinking in one single operation. Well suitable for soft wood and limited applicable for European hard wood.
	Alloyed tool steel		For hard wood we recommend our brad point drill bit, product line 1594 (HSS-G) and adjustable countersink product line VARIO 2202. Put the depth adjusting collar 2108.216 directly on the countersink and set the lowering depth
	1500 - 2200 rpm. e.g. standard value approx. 1800 rpm in soft wood		Packing unit = 1, Rose-tube

3572

 Classic

Drill Bit - Countersink Set, HSS

FAMAG®
...für Besserbohrer®







Art. No.	O-Ø [mm]	Shank [mm]	OAL [mm]	Effective L. [mm]	€
3572.030	3	C 6,3	75	25	15,05
3572.040	4	C 6,3	75	25	15,20
3572.050	5	C 6,3	86	36	15,85
3572.060	6	C 6,3	93	43	16,40
3572.080	8	C 6,4	117	67	21,75
3572.100	10	C 6,5	133	83	24,15

Accessory

Art. No.	Description	€
2108.216	depth adjusting collar for countersinks type 2100: 3 - 7 mm	5,55

Sets

Art. No.	Description	€
3572.503	5 pcs. Set in wooden case. Drill bits Ø 3, 4, 6 mm with countersinks type 2100, bitholder and depth stop collar 2108.216	61,85
3572.504	5 pcs. Set in wooden case. Drill bits Ø 3, 4, 5, 6 mm with countersinks type 2100 with depth stop collar type 2018.216	80,80

	Brad point drill bit fully ground with two main cutting edges, two taper taps and hexagaonal shank for bit-holder (1/4"; C 6,3). With assembled countersink product line 2100 (alloyed tool steel)		For very fast change in bit holders. Drilling and countersinking in soft wood in one single operation. Only limited applicable for hard wood
	Drill bit: HSS; countersink: alloyed tool steel		For hard wood we recommend our brad point drill bits product line 1594 (HSS-G) and countersink product line VARIO 2202. Put the depth adjusting collar 2108.216 directly on the countersink and set the lowering depth
	1500 - 2200 rpm. e.g. standard value approx. 1800 rpm in soft wood		Packing unit = 1, Rose-tube

Technical changes or mistakes reserved! All prices are recommended retail prices additionally value added tax.

2202

○○○○
Excellent

Adjustable Countersink VARIO, TCT



Art.- No.	∅ [mm]	O-∅ [mm]	OAL [mm]	> [°]	€
2202.000	3 - 8	10,5 - 14,5	34	90	35,65
2204.000	3 - 8	10,5 - 14,5	35	180	35,65

Sets

Art.- No.	Description	€
3575.505	6 pcs. Set in wooden case, brad point drill bit HSS, type 1594 ∅ 3, 4, 5, 6, 8 mm incl. VARIO Countersink 2202 (90°)	63,10
3575.504	6 pcs. Set in wooden case, brad point drill bit HSS, type 1594 ∅ 3, 4, 5, 6, 8 mm incl. VARIO Countersink 2204 (180°)	63,10
3575.507	6 pcs. Set in wooden case, brad point drill bit TCT, type 1593 ∅ 3, 4, 5, 6, 8 mm incl. VARIO Countersink 2202 (90°)	119,00

	Professional carbide tipped adjustable countersink, countersinking angle 90° or 180°, two-part version. Can be clipped universally on all drill bits ∅ 3-8 mm, incl. allen key. ∅ 8 mm must be pushed into the countersink from behind with the flute in front		Drilling and countersinking in one single operation by direct clipping on drill bits (also intermediate sizes e.g. 5.5 mm). Suitable for all sorts of wood, laminated panels and many plastics like acrylic glass, Corian, GFRP, HPL coating, polycarbonate, PVC and Trespa board
	TCT		Countersinking of screw heads and drilling at the same time. Once the VARIO is fitted, you get the following dimensions (∅ drill bit/countersink size); 3/12 4/12,5 5/13,5 6/14,5 7/16 8/17,5 mm
	3000 - 5000 rpm. e.g. Drill-∅ 4 mm 4000 rpm in European hard wood, also possible with less speed in cordless screwdrivers		Packing unit = 1, Rose-tube

Technical changes or mistakes reserved! All prices are recommended retail prices additionally value added tax.









Art.- No.	Description	€
3577.040	Drill-bit Countersink Set 4 mm with depth stop	32,00
3577.050	Drill-bit Countersink Set 5 mm with depth stop	32,00
3577.060	Drill-bit Countersink Set 6 mm with depth stop	32,00

Sets

Art.- No.	Description	€
3577.504	Drill-Countersink Set of 4 pcs. Ø 4, 5, 6 mm and Depth Stop in wooden case	75,40

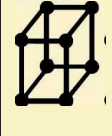
Accessory

Art.- No.	Description	€
3577.104	Countersink single l-Ø 4 mm	15,75
3577.105	Countersink single l-Ø 5 mm	15,75
3577.106	Countersink single l-Ø 6 mm	15,75
3577.140	Pre-drill Ø 4 mm	4,50
3577.150	Pre-drill Ø 5 mm	4,95
3577.160	Pre-drill Ø 6 mm	5,80
3577.212	Depth stop single, rotationally supported	18,00

	High quality drill bit - countersink set with rotating depth stop (brass). Depth of pre-drill is adjustable. Countersink angle 60°		This set is particularly well suited for terrace construction. It makes it easy to drill screwholes and to countersink them properly and accurate in the terrace boards. The depth stop is rotatably mounted and stops when it touches the workpiece. This prevents the depth stop from leaving marks on the terrace boards.
	Countersink/Pre-drill: alloyed tool steel. Depth Stop: brass		Adjust the depth so that the floor board is just perforated (board thickness). Thus, the self-tapping terrace screw can find a perfect hold state.
	1500 - 2200 rpm, e.g. recommended value approx. 1800 rpm in hard wood		Packing unit = 1, Rose tube

2101

Profi

Countersink, HSS



Art.- No.	∅ [mm]	O-∅ [mm]	OAL [mm]	€
2101.030	3,0	16	16	41,65
2101.035	3,5	16	16	41,65
2101.040	4,0	16	16	41,65
2101.045	4,5	16	16	41,65
2101.050	5,0	16	16	41,65
2101.060	6,0	16	16	41,65
2101.070	7,0	16	16	41,65
2101.080	8,0	18	16	44,85
2101.100	10,0	20	16	45,75

	Countersink with two edges and point angle 90°, to be clipped on drill bits		Drilling and countersinking in one single operation. For fitting on drill bits. Suitable for soft wood, European hard wood, veneered panels and plastics like acrylic glass, Corian®, GFRP, HPL coating, polycarbonate, PVC and Trespa® board
	HSS		Countersinking of screw heads and drilling at the same time. Long service life due to the HSS material. We recommend to use the drill bits product line 1594. Not suitable for depth adjusting collar 2106.216
	2000 - 3500 rpm. e.g. standard value ca. 3000 rpm in European hard wood, also suitable for use in cordless screwdrivers, but with clearly less speed		Packing unit = 1, Rose-tube

2106

Profi

Countersink 180°, HSS



Art.- No.	∅ [mm]	O-∅ [mm]	OAL [mm]	€
2106.050	5	15	23	42,15
2106.060	6	16	23	43,45
2106.061	6	15	25	43,90
2106.180	8	20	25	50,30
2106.280	8	25	25	52,90
2106.290	9	25	25	55,10
2106.110	10	20	25	48,40
2106.210	10	25	25	52,85
2106.211	11	25	25	70,20
2106.310	10	30	25	80,45
2106.212	12	25	25	67,35
2106.312	12	30	25	80,45





	Countersink for straight countersinking with two main cutting edges and two taper taps; to be clipped on drill bits		Drilling and countersinking in one single operation. For fitting on drill bits. Suitable for soft wood, European hard wood, veneered panels and plastics like acrylic glass, Corian®, GFRP, HPL coating, polycarbonate, PVC and Trespa® board
	HSS		For countersinking of washers/screw nuts and drilling at the same time. For drill bits with ∅ 3-8 mm. Our product line VARIO 2204 might be a cost-efficient solution
	1700 - 3000 rpm. e.g. ∅ 12 mm 2000 rpm in European hard wood, also suitable for use in cordless screwdrivers, but with clearly less speed		Packing unit = 1, Rose-tube



Art.- No.	O-Ø [mm]	SØ [mm]	OAL [mm]	€
1540.001	15 - 45	12	150	47,85
1540.002	22 - 76	13	150	59,75
1540.003	22 - 100	13	150	130,25

spare blades

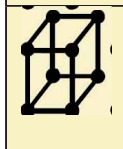
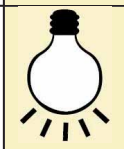
Art.- No.	O-Ø [mm]	€
1540.101	15 - 25	13,85
1540.102	25 - 45	14,40
1540.201	22 - 40	14,40
1540.202	40 - 76	17,95
1540.203	70 - 100	65,85

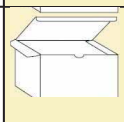
	Version with centre point, one fixed main cutting edge and adjustable knife with taper tap. Adjustable center bit with a solid cylindrical shank 13 x 50 mm		For drilling in soft wood, universal for all diameters and intermediate sizes
	Alloyed tool steel		Suitable for stationary use only. This tool is a compromise, for professional use we recommend our cylinder boring bits as e.g. our product line Bormax ® 2.0
	300 - 1500 rpm. e.g. for Ø 50 mm 600 rpm in soft wood, stationary use		Packing unit = 1, Rose-tube

3510

Hobby

Flat Centre Bit

FAMAG®
...für Besserbohrer®







Art.- No.	O-Ø [mm]	SØ [mm]	OAL [mm]	Effective L. [mm]	€
3510.008	8	E 6,3	150	120	3,50
3510.010	10	E 6,3	150	120	3,50
3510.011	11	E 6,3	150	120	3,55
3510.012	12	E 6,3	150	120	3,55
3510.013	13	E 6,3	150	120	3,75
3510.014	14	E 6,3	150	120	3,75
3510.015	15	E 6,3	150	120	3,80
3510.016	16	E 6,3	150	120	3,80
3510.017	17	E 6,3	150	120	4,15
3510.018	18	E 6,3	150	120	4,15
3510.019	19	E 6,3	150	120	4,25
3510.020	20	E 6,3	150	120	4,25
3510.021	21	E 6,3	150	120	4,30
3510.022	22	E 6,3	150	120	4,30
3510.025	25	E 6,3	150	120	4,55
3510.028	28	E 6,3	150	120	4,75
3510.032	32	E 6,3	150	120	5,65
3510.034	34	E 6,3	150	120	6,35
3510.036	36	E 6,3	150	120	7,40
3510.038	38	E 6,3	150	120	7,50
3510.040	40	E 6,3	150	120	8,20

Extension

Art.- No.	O-Ø [mm]	SØ [mm]	OAL [mm]	Effective L. [mm]	€
3511.000	16	E 6,3	305	280	10,25

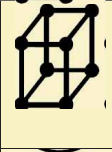
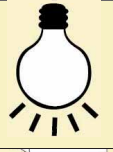
Sets

Art.- No.	Description	€
3510.506	6 pcs. Set in plastic box Ø 12, 16, 18, 20, 22, 25 mm	21,80

	Classical centre bit with centre point. Polished face with two taper taps and bit shank E 6,3. The extension shank 3511.305 has a quick-action chuck		For drilling in soft wood without any particular precision and quality. Due to the taper taps the results are clearly better than the usual versions
	Alloyed tool steel		In our opinion flat centre bits are in principal no tools for professional use and are not suitable for hard wood. We recommend to use FAMAG cylinder boring bits, especially the product lines Bormax® 2.0 (alloyed tool steel / TCT)
	800 - 3000 rpm. e.g. Ø 18 mm 1600 rpm in soft wood. Further details in the speed diagram		Packing unit = 1, on Rose-card

Hole Saws

69

PAROLI all-round	70
PAROLI all-round 50, TCT- Hole Saw	71
PAROLI all-round 165, TCT-Hole Saw, Long Version	72
PAROLI 100 Hole Saw for Insulating Material	73
PAROLI Bi-Metal Hole Saw, HSS-Co	74
Universal Hole Saw, TCT	75
Bi-Metal Hole Saw , HSS-Co, for Roller Shutter	76
Bi-Metal Hole Saw for Carpentry, HSS-Co	77

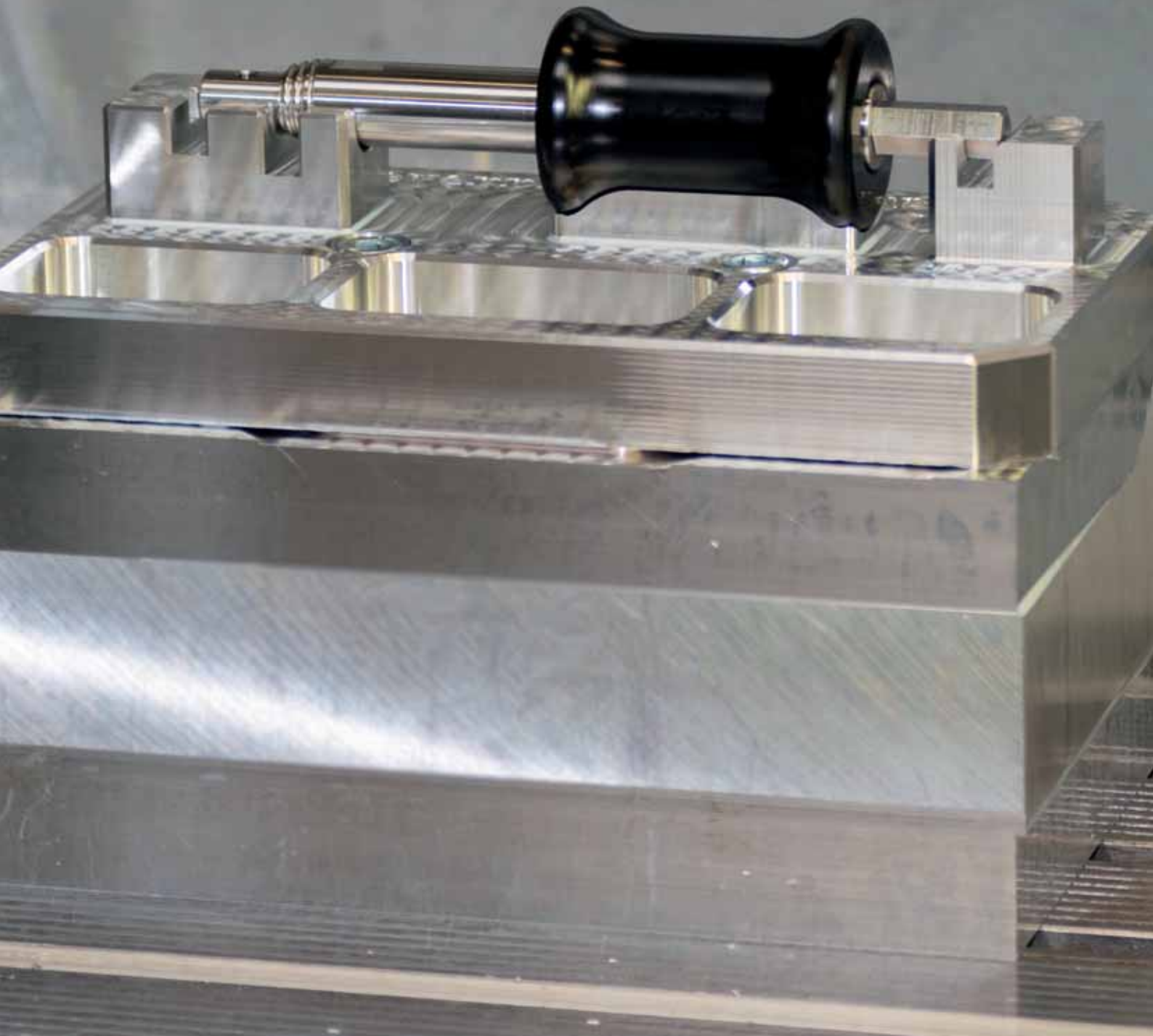



Paroli Pumpshank®

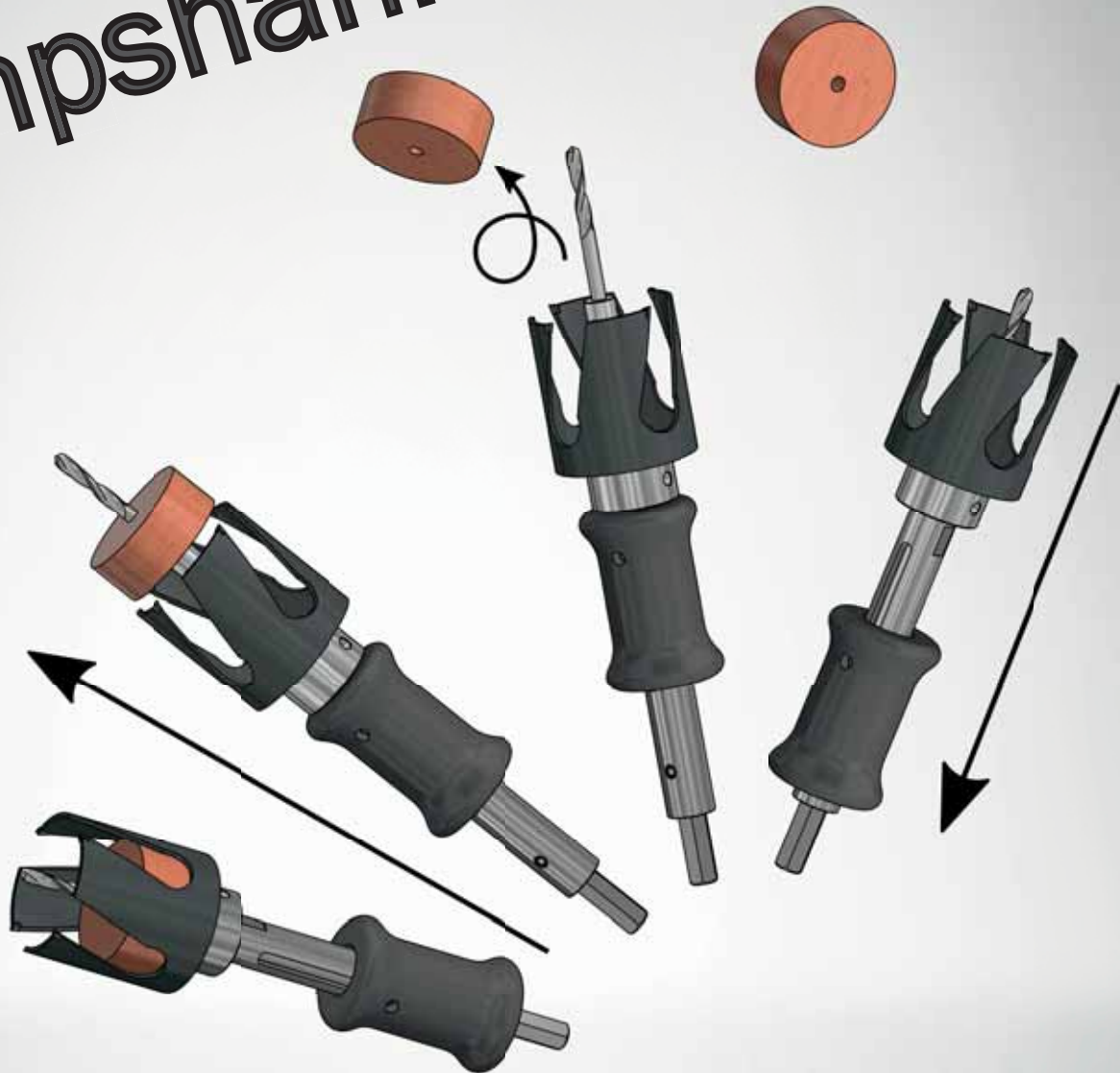



Art.- No.	Description	O-Ø [mm]	AØ [Inch]	Effective L. [mm]	€
2166.035	End of Series	35	1 3/8	50	17,30
2166.040		40	1 9/16	50	17,30
2166.045		45	-	50	17,95
2166.050		50	-	50	22,50
2166.051		51	2	50	22,50
2166.054		54	2 1/8	50	22,95
2166.057		57	2 1/4	50	23,20
2166.060		60	2 3/8	50	24,55
2166.064		64	2 1/2	50	28,20
2166.065		65	2 9/16	50	28,20
2166.068		68	2 11/16	50	29,80
2166.070		70	2 3/4	50	30,30
2166.073		73	2 7/8	50	30,30
2166.074		74	-	50	30,30
2166.076		76	3	50	32,05
2166.080		80	-	50	31,40
2166.082		82	-	50	31,40
2166.086		86	3 3/8	50	32,95
2166.092		92	3 5/8	50	32,95
2166.102		102	4	50	41,90
2166.105		105	4 1/8	50	41,90
2166.111		111	4 3/8	50	45,30
2166.114		114	4 1/2	50	47,00
2166.121		121	4 3/4	50	60,95
2166.125		125	-	50	64,95
2166.133		133	5 1/2	50	72,30
2166.140		140	5 1/2	50	72,30
2166.152		152	6	50	82,30
2166.160		160	6 5/16	50	94,20
2166.165		165	-	50	98,60
2166.177		177	7	50	107,75
2166.185		185	-	50	118,10
2166.210		210	8 1/4	50	128,20

Edge countersink cap

Art.- No.	Description	€
2166.468	Edge countersink cap Ø 68mm for wall sockets	27,80

Ejector-shank system

Art.- No.	Description	€
2166.605	Pumpshank® incl. adapter and HSS-G centre drill	79,95
2166.606	Pumpshank® incl. 3 adapters and HSS-G centre drill	99,95
2166.607	single adapter	10,95
2166.608	Set of 5 pcs of adapters	49,95
2166.626	single HSS-G centre drill Ø 6 mm for Pumpshank®	7,95
2166.636	single TCT centre drill Ø 6 mm for Pumpshank®	9,95

Sets

Art.- No.	Description	€
2166.808	8 pcs. Set Ø 45, 50, 57, 60, 68, 80 incl. edge countersink cap for Ø 68 mm + Pumpshank incl. 6 adapters & HSS centre drill	259,95







	Carbide tipped hole saw, the saw body is made of steel, cutting depth 50 mm		Round sawing in all kinds of woods and boards, MDF, aerated concrete, plaster board, tile (up to a scratch hardness of 6) and plastics like acrylic glass, Corian, GFRP, HPL coating, polycarbonate, PVC and Trespa board
	TCT		By using the particularly clever ejector-shank system, you can easily remove the core and save a lot of time and trouble. Perfect run-out thanks to massive ground and one-piece saw body
	For larger diameters a high torque is needed. Rotation speed according to the corresponding diagram		packing unit: 1, SB Rose clip



Art.- No.	O-Ø [mm]	Effective L. [mm]	€
2169.051	51	165	70,05
2169.060	60	165	78,70
2169.070	70	165	92,85
2169.080	80	165	104,45
2169.102	102	165	117,85
2169.111	111	165	131,75
2169.121	121	165	153,20
2169.130	130	165	177,35
2169.152	152	165	203,40
2169.160	160	165	258,45

Ejector-shank system

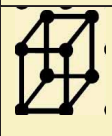
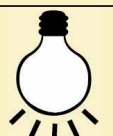
Art.- No.	Description	€
2169.310	Ejector-shank incl. guiding spike for PAROLI 165	35,15
2169.309	Ejector-shank for PAROLI 165	27,15
2169.320	single guiding spike Ø 10 mm for PAROLI 165	8,15

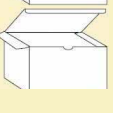



	<p>Carbide tipped hole saw, the saw body is made of steel, cutting depth 165 mm</p>		<p>Round sawing in all kinds of woods and boards (also solid wood), MDF, aerated concrete, plaster board and plastics. The long version is ideal for drilling clearing holes in solid wood for ventilating pipes, drain pipes and flue</p>
	<p>TCT</p>		<p>By using the particularly clever ejector-shank system, you can easily remove the core and save a lot of time and trouble. After the saw has bitten, the spike can be removed</p>
	<p>For larger diameters a high torque is needed. Rotation speed according to the corresponding diagram</p>		<p>packing unit: 1, SB Rose clip</p>



Art.- No.	Description	O-Ø [mm]	Effective L. [mm]	€
2155.035	Junction box for wall lamps	35	100	63,95
2155.065	Facade dowel	65	100	88,85
2155.068	Hollow wall box, junction box	68	100	100,00
2155.074	Hollow wall box, junction box	74	100	111,10
2155.106	Blow-in opening insulation	106,5	100	165,60
2155.121	Fire protection – halogen lamp – casing	121	100	177,80

Ejector shank system

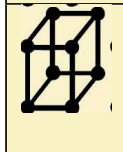
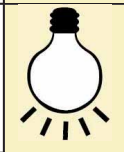
Art.- No.	Description	€
2155.311	Ejector-shank for 2155 (wrench size 11mm)	22,20

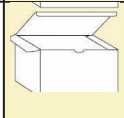
	<p>The first hole saw with serrated knife for really all insulating materials such as: Wood insulating boards, polystyrene, mineral wool, PU-foam etc. Very clean cuts</p> <p>The ejector-shank has to be ordered separately! It is not included in the scope of delivery</p>		<p>Fast, very clean and circular cuts in mineral wool, PUR foam, polystyrene, leather, rubber, paper, carpet and especially in wood fiber insulating boards</p>
	<p>Alloyed tool steel</p>		<p>Due to the ejector shank system the drill core can be removed in a breath. The thin-walled cutting offers to use the core again, e.g. to close the blow-in opening</p>
	<p>According to the corresponding diagram</p>		<p>packing unit = 1, SB packaging PE Clip, Ø 106 + 121 in carton</p>



Art.- No.	O-Ø [mm]	AØ [Inch]	Effective L. [mm]	€
2173.014	14	9/16	35	17,20
2173.016	16	5/8	35	17,20
2173.017	17	11/16	35	17,20
2173.019	19	3/4	35	17,20
2173.020	20	-	35	17,20
2173.021	21	13/16	35	17,20
2173.022	22	7/8	35	17,20
2173.024	24	15/16	35	17,75
2173.025	25	-	35	17,80
2173.029	29	-	35	17,80
2173.030	30	1 3/16	35	17,80
2173.032	32	1 1/4	35	18,30
2173.033	33	1 5/16	35	18,30
2173.035	35	1 3/8	35	19,15
2173.037	37	1 7/16	35	19,15
2173.038	38	1 1/2	35	19,15
2173.040	40	1 9/16	35	20,20
2173.041	41	1 5/8	35	20,20
2173.043	43	1 11/16	35	21,85
2173.044	44	1 3/4	35	22,40
2173.046	46	1 13/16	35	22,40
2173.048	48	1 7/8	35	22,40
2173.051	51	-	35	22,40
2173.052	52	2 1/16	35	23,55
2173.054	54	2 1/8	35	23,55
2173.057	57	2 1/4	35	24,85
2173.059	59	2 5/16	35	25,85
2173.060	60	2 3/8	35	25,85
2173.064	64	2 1/2	35	27,10
2173.065	65	2 9/16	35	27,10
2173.067	67	2 5/8	35	27,50
2173.068	68	2 11/16	35	27,50
2173.070	70	2 3/4	35	28,25
2173.073	73	2 7/8	35	28,25
2173.076	76	-	35	29,50
2173.083	83	3 1/4	35	30,05
2173.086	86	3 3/8	35	30,05
2173.089	89	3 1/2	35	30,05
2173.092	92	3 5/8	35	34,10
2173.095	95	3 3/4	35	35,75
2173.098	98	3 7/8	35	37,40
2173.102	102	-	35	38,45
2173.105	105	4 1/8	35	42,40
2173.108	108	4 1/4	35	47,95
2173.111	111	4 3/8	35	51,05
2173.114	114	4 1/2	35	56,65
2173.121	121	4 3/4	35	59,55
2173.127	127	-	35	61,40
2173.133	133	5 1/2	35	65,35
2173.140	140	5 1/2	35	69,85
2173.146	146	-	35	72,05
2173.152	152	-	35	77,45
2173.160	160	6 5/16	35	110,40
2173.168	168	6 5/8	35	114,55
2173.177	177	-	35	118,90
2173.200	200	-	35	133,25
2173.210	210	8 1/4	35	139,90



Bi-metal hole saw with HSS teeth, variable pitch, weld on a cylindrical tool head of steel. Cutting depth 35 mm. With help of the Pumpshank system the saw core can be removed easily



Round sawing in steel and nonferrous metal as copper, bronze and aluminium with box column drill or power drill. Due to the high quality cobalt alloy and the special polished section, you receive a better cutting performance and a longer service life

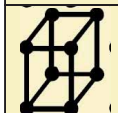

HSS Bi-Metal, M42, 8% Co

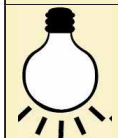

We recommend to cool the hole saw with cutting oil when carving metal. For plastics, plaster and derived timber products, we recommend the PAROLI All-Round 50 TCT universal hole saw, product line 2166

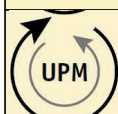

According to the corresponding diagram

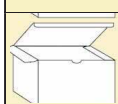

packing unit = 1, Rose clip

Adapter		€
Art.- No.	Description	
2166.605	Pumpshank® incl. adapter and HSS-G centre drill	79,95
2166.607	single adapter	10,95
2166.606	Pumpshank® incl. 3 adapters and HSS-G centre drill	99,95
2173.901	Adaptor 14 - 30 mm AF 9,5 mm incl. HSS-centre drill	10,25
2173.905	Adaptor 32-210 mm AF 11,0 mm incl. HSS-centre drill	16,10
2173.907	Adaptor 14 - 30 mm with SDS-shank incl. HSS-centre drill	19,05
2173.908	Adaptor 32-210 mm with SDS-shank incl. HSS-centre drill	19,05



Art.- No.	O-Ø [mm]	Teeth	Effective L. [mm]	€
2160.030	30	3	60	47,05
2160.040	40	3	60	57,25
2160.050	50	3	60	67,50
2160.055	55	3	60	68,60
2160.060	60	5	60	69,55
2160.065	65	5	60	77,80
2160.068	68	5	60	76,60
2160.080	80	5	60	117,70
2160.090	90	5	60	128,65
2160.105	105	6	60	160,30

Edge countersink

Art.- No.	O-Ø [mm]	Teeth	€
2160.468	68	3	49,00

Shank

Art.- No.	O-Ø [mm]	IØ [mm]	OAL [mm]	SØ [mm]	€
2160.201	M16	8	70	13	26,65
2160.203	M16	8	70	SDS	32,00

Centre drill

Art.- No.	O-Ø [mm]	Mat.	OAL [mm]	SØ [mm]	€
2160.307	10	HM	130	8	9,50
2160.308	8	HSS	120	8	10,05

	Carbide tipped hole saw, the saw body is made of tempered steel. Internal thread M16 for intake of the shank. Maximum cutting depth 60 mm		Drilling in plaster boards, aerated concrete, plastics, chipboards and plywood. Please order shanks and centre drills separately
	TCT		With the edge countersink you are able to countersink the lid of a flush socket, suitable for hole saw 2160.068
	For larger diameters a high torque is needed. Rotation speed according to the diagram		packing unit = 1, Plastic sleeve



Holesaw incl. shank and pre-drill

Art.- No.	O-Ø [mm]	SØ [mm]	OAL [mm]	Effective L. [mm]	€
2174.017	17	12	220	100	66,55
2174.022	22	12	220	100	66,55
2174.025	25	12	220	100	66,55

Holesaw without shank and pre-drill

Art.- No.	O-Ø [mm]	OAL [mm]	Effective L. [mm]	€
2174.117	17	140	100	44,45
2174.122	22	140	100	44,45
2174.125	25	140	100	44,45

Accessory

Art.- No.	Description	€
2174.301	Hexagonal shank complete with pre-drill Ø 7 mm	22,20
2174.307	Pre-drill Ø 7 mm for holesaw 2174	6,15



Special hole saw of HSS bi-metal to install roller shutters in window frames. Incl. hexagonal shank and pre-drill bit to place the hole saw in position



During the installation of the roller shutter you have to drill holes in the window frames for the belts. This was always an issue, but with this hole saw it is properly solved

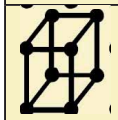

HSS Bi-metal



Remove the pre-drill bit from the hole saw after the first cut. This reduces the cutting forces and it works much more easier

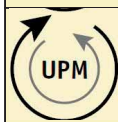

500 - 750 rpm



packing unit = 1, PE tube



Art.- No.	O-Ø [mm]	SØ [mm]	OAL [mm]	Effective L. [mm]	€
2170.086	85	SW 12	420	300	226,60
2170.111	110	SW 12	420	300	284,70
2170.130	130	SW 12	420	300	336,50
2170.152	152	SW 12	420	300	420,55
2170.170	170	SW 12	420	300	465,90
2170.200	200	SW 12	420	300	549,95

Guiding spike and drill head

Art.- No.	O-Ø [mm]	SØ [mm]	OAL [mm]	Effective L. [mm]	€
2170.030	20	12	470	410	77,70

Guiding spike single





Art.- No.	O-Ø [mm]	SØ [mm]	OAL [mm]	Effective L. [mm]	€
2170.010	19,5	12	430	380	55,70

Drill head single

Art.- No.	O-Ø [mm]	SØ [mm]	OAL [mm]	Effective L. [mm]	€
3690.002	8 - 20	8	70	40	29,40

Hexagonal shank

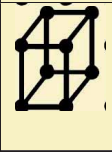
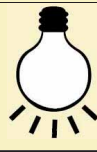
Art.- No.	Description	€
2170.005	Hexagonal shank for carpentry bi-metal hole saw AF12	31,25

	Special hole saw bi-metal with variable tooth pitch. Teeth made of HSS are welded on a cylindrical base body which has a usable length of 300 mm. Incl. exchangeable hexagonal shank (AF12). Please order guiding spike with drill head separately.		For drilling large diameter holes in one workstep e.g. the lead through of flue pipes and incoming air pipes in roof constructions. This high quality hole saw cuts all sorts of insulating materials (fibreglass, rockwool, styrofoam etc.) as well as wood/chipboards and gypsum plaster boards
	Bimetal HSS M42, 8% Co		The cutting of solid wood with a thickness of more than 30 mm, as well as cutting of stone and metal is not possible due to the finish of the hole saw. The hole saw for carpentry can be used freehand without any support with a strong power drill
	For larger Ø approx. 500 rpm		packing unit = 1, yellow cardboard tube

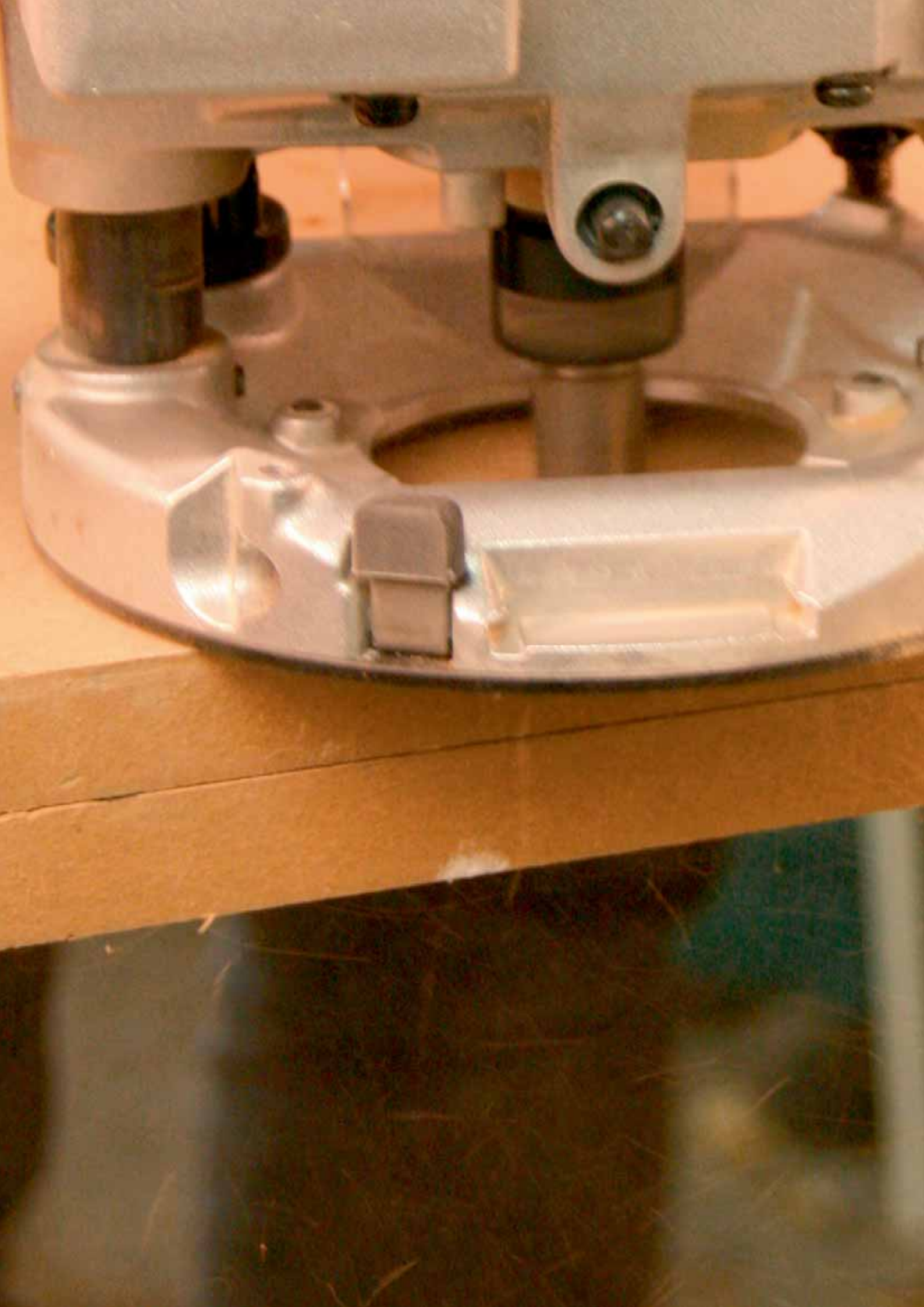





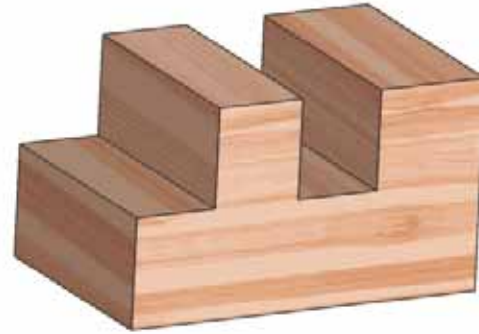
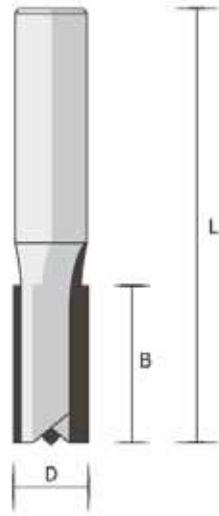

Router Bits

79

Straight Bit for Plunging, two Flutes	80
Classical Bit, Plunge Type, two Flutes	86
Chamfer Bit, two Flutes	90
Bull Nose Bit (Half Round), two Flutes	92
Cove Bit, two Flutes	93
Panelling Bit, two Flutes	95
Straight Bit, Plunge, one Flute	99
Ball Bearings	102



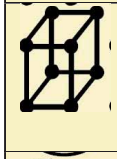
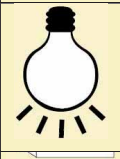



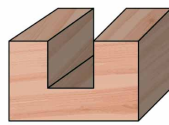
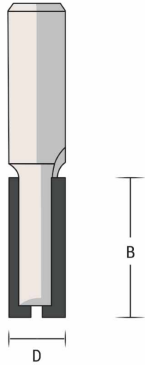

Art.- No.	D [mm]	Cutting l. [mm]	L [mm]	α [°]	R1 [mm]	R2 [mm]	SØ [mm]	n max. [RPM]	€
3167.008	8	32	63				8	26.000	40,95
3167.010	10	32	63				8	24.000	42,00
3167.014	14	32	63				8	22.000	48,95
3167.016	16	32	63				8	21.000	52,90
3167.018	18	32	63				8	21.000	53,75
3167.020	20	32	63				8	20.000	57,85
3167.808	8	19	57				8	26.000	38,65
3167.810	10	19	51				8	24.000	39,70
3167.812	12	19	51				8	22.000	41,70
3167.842	12	32	63				8	22.000	50,30
3167.814	14	19	51				8	22.000	43,50
3167.844	14	25	57				8	22.000	46,45
3167.816	16	19	51				8	21.000	45,40
3167.846	16	25	57				8	21.000	48,35
3167.818	18	19	51				8	21.000	48,05
3167.848	18	25	57				8	21.000	50,75
3167.820	20	19	51				8	20.000	50,45
3167.908	8	25	69				12	26.000	40,95
3167.910	10	19	63				12	24.000	42,00
3167.912	12	19	61				12	22.000	43,85
3167.942	12	32	73				12	22.000	50,30
3167.944	14	25	67				12	22.000	48,95
3167.916	16	25	67				12	21.000	51,00
3167.946	16	32	73				12	21.000	52,95
3167.918	18	25	67				12	21.000	53,75
3167.920	20	25	67				12	20.000	56,80
3167.922	22	32	73				12	20.000	64,25

	Two carbide tipped cutting edges, side cutting and plunging. With ground and carbide tipped front cutter		For grooving, producing finger jointers, tongue and groove joints. Due to the carbide tipped front side cutting edge, you can use it indefinitely for plunging. Suitable for all kinds of solid wood, wooden and laminated materials and some plastics. Manual and mechanical feed is allowed
	TCT (cutting edges, front cutter)		Due to the carbide tipped front side cutting edge, this article is particularly ideal for milling slots and continuous cut outs up to a depth of 32 mm. Also appropriate for milling the cut outs of worktops in kitchens (e.g. hob and sink)
	Individually for each router bit, see product parameter		packing unit = 1, SB packaging

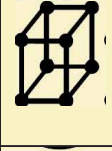

Art.- No.	D [mm]	Cutting l. [mm]	L [mm]	α [°]	R1 [mm]	R2 [mm]	SØ [mm]	n max. [RPM]	€
3107.603	3	11	51				6	26.000	25,15
3107.604	4	11	51				6	25.000	25,30
3107.605	5	11	51				6	24.000	25,55
3107.606	6	19	51				6	23.000	25,85
3107.608	8	20	51				6	22.000	31,30
3107.610	10	20	51				6	22.000	32,10
3107.651	10	32	63				6	22.000	37,55
3107.612	12	20	51				6	20.000	33,80
3107.661	12	32	63				6	20.000	39,00
3107.614	14	20	51				6	20.000	34,65
3107.616	16	20	51				6	19.000	36,75
3107.618	18	20	51				6	19.000	39,00
3107.620	20	20	51				6	18.000	41,65
3107.803	3	11	51				8	26.000	25,15
3107.804	4	11	51				8	25.000	25,30
3107.805	5	11	51				8	24.000	25,55
3107.806	6	19	51				8	23.000	25,85
3107.808	8	20	51				8	22.000	31,30
3107.810	10	20	51				8	22.000	32,10
3107.851	10	32	63				8	22.000	37,55
3107.812	12	20	51				8	20.000	33,80
3107.861	12	32	63				8	20.000	39,00
3107.814	14	20	51				8	20.000	34,65
3107.816	16	20	51				8	19.000	36,75
3107.818	18	20	51				8	19.000	39,00
3107.820	20	20	51				8	18.000	41,65
3107.822	22	20	51				8	18.000	42,35
3107.825	25	20	51				8	17.000	45,35
3107.908	8	25	70				12	26.000	38,20
3107.910	10	32	76				12	24.000	40,70
3107.912	12	32	73				12	22.000	41,70
3107.962	12	50	108				12	22.000	60,60
3107.914	14	25	73				12	22.000	42,30
3107.916	16	32	73				12	21.000	43,10
3107.918	18	32	73				12	21.000	47,00
3107.920	20	32	73				12	20.000	49,50
3107.922	22	25	67				12	20.000	50,00
3107.925	25	32	73				12	19.000	60,00
3107.930	30	25	67				12	18.000	76,55
3107.935	35	25	67				12	18.000	82,50
3107.940	40	32	73				12	17.000	115,25
3107.950	51	32	73				12	17.000	138,00

	Two carbide tipped cutting edges parallel to the axis, side cutting and plunging . With ground (not carbide tipped) front cutter		For grooving, fixing of box joints, folding and producing of tongue and groove joints. Suitable for all kinds of solid wood, wooden and laminated materials and some plastics. Manual and mechanical feed is allowed
	TCT (cutting edges)		For professional plunging we recommend our product line 3167 with carbide tipped front side cutting edge
	Individually for each router bit, see product parameter		packing unit = 1, SB packaging

3157







Excellent

Straight Bit, Template Profile, two Flutes

FAMAG®
...für Besserbohrer®

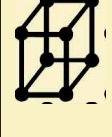
Art.- No.	D [mm]	Cutting l. [mm]	L [mm]	< [°]	R1 [mm]	R2 [mm]	SØ [mm]	n max. [RPM]	€
3157.625	15,9	25,4	63				6	19.000	47,50
3157.816	16	25,4	63				8	19.000	47,50
3157.819	19	25,4	63				8	19.000	47,50

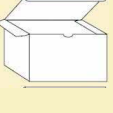
	Two carbide tipped side cutting edges parallel to the axis. With ball bearing guide (Ø 15.9 mm) on the side of the shank		For grooving any profile with a template. Suitable for all kinds of solid wood, wooden and laminated materials and some plastics. Manual and mechanical feed is allowed
	TCT (cutting edges)		After producing a template you can groove the same profile in any workpiece with the straight bit.
	Individually for each router bit, see product parameter		packing unit = 1, SB packaging

3108



Excellent

Slotting Cutter

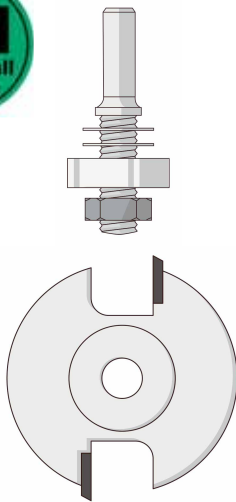
FAMAG®
...für Besserbohrer®







Art.- No.	D [mm]	Cutting l. [mm]	d. [mm]	< [°]	R1 [mm]	R2 [mm]	SØ [mm]	n max. [RPM]	€
3108.015	40	1,5	6,35					16.000	24,15
3108.020	40	2,0	6,35					16.000	24,15
3108.025	40	2,5	6,35					16.000	24,90
3108.030	40	3,0	6,35					16.000	26,60
3108.035	40	3,5	6,35					16.000	27,10
3108.040	40	4,0	6,35					16.000	27,10
3108.050	40	5,0	6,35					16.000	27,10
3108.060	40	6,0	6,35					16.000	27,10

shank with ball bearing

Art.- No.	D [mm]	Cutting l. [mm]	L [mm]	SØ [mm]	R1 [mm]	n max. [RPM]	R2 [mm]	n max. [RPM]	€
3108.690	15,9	58		6		16.000			23,90
3108.890	15,9	58		8		16.000			23,90

shank without ball bearing

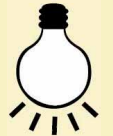
Art.- No.	D [mm]	Cutting l. [mm]	L [mm]	SØ [mm]	R1 [mm]	n max. [RPM]	R2 [mm]	n max. [RPM]	€
3108.691	13	58	6,35	6		16.000			13,05
3108.891	13	58	6,35	8		16.000			13,05

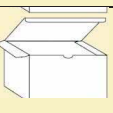
	Two carbide tipped, straight side cutting edges		For cutting grooves and slots. Suitable for all kinds of solid wood, wooden and laminated materials and some plastics. Manual and mechanical feed is allowed
	TCT (cutting edges)		Specially for tongue and groove joints, production of plugs, cutting slots in general and special slots for the application of Lamello joints (B = 4,0 mm). For constant cutting depth of slots we recommend the version with ball bearing guide
	Individually for each router bit, see product parameter		packing unit = 1, SB packaging

Technical changes or mistakes reserved! All prices are recommended retail prices additionally value added tax.

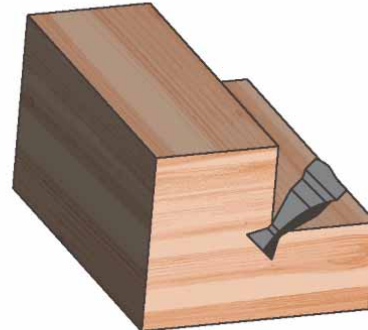
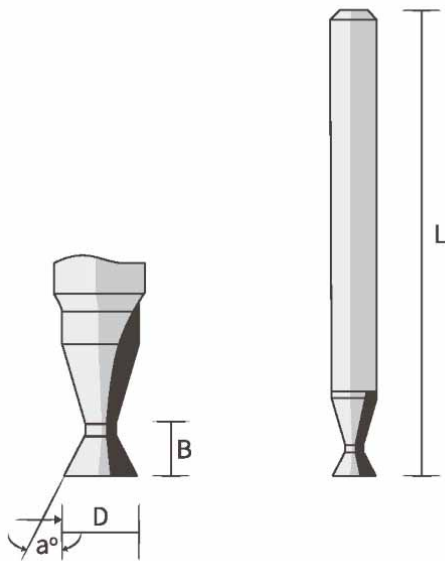
**One-sided**

Art.- No.	D [mm]	Cutting l. [mm]	L [mm]	< [°]	R1 [mm]	R2 [mm]	SØ [mm]	n max. [RPM]	€
3107.663	3	11	60				6	30.000	31,30
3107.763	3	11	60				6,35	30.000	31,30

Double-sided





Art.- No.	D [mm]	Cutting l. [mm]	L [mm]	< [°]	R1 [mm]	R2 [mm]	SØ [mm]	n max. [RPM]	€
3107.673	3	8	70				6	30.000	51,75
3107.773	3	8	70				6,35	30.000	51,75

Dovetailed profile

Art.- No.	D [mm]	Cutting l. [mm]	L [mm]	< [°]	R1 [mm]	R2 [mm]	SØ [mm]	n max. [RPM]	€
3104.665	5	8	60	18			6	30.000	55,10
3104.765	5,5	8	60	18			6,35	30.000	55,10

Studded anchor profile

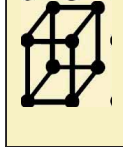
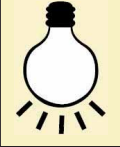
Art.- No.	D [mm]	Cutting l. [mm]	L [mm]	< [°]	R1 [mm]	R2 [mm]	SØ [mm]	n max. [RPM]	€
3104.685	5	8	65	38			6	30.000	64,60
3104.785	5,5	8	65	38			6,35	30.000	64,60

	Two carbide tipped cutting edges parallel to the axis, fully ground, side cutting and plunging		For milling straight or molded lining grooves at windows or doors. Suitable for all kinds of solid wood, wooden and laminated materials and some plastics. Manual and mechanical feed is allowed
	Solid carbide, 3104 with head of solid carbide		By using fine grained carbide the straight bits of FAMAG have a very high service life. With appropriate feed it is possible to make the lining groove in one single operation
	Individually for each router bit, see product parameter		packing unit = 1. SB packaging



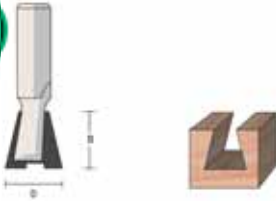

3104

 Excellent

Dovetail Bit, two Flutes

FAMAG
...für Besserbohrer

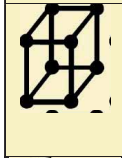
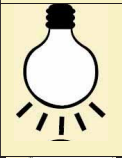
Art.- No.	D [mm]	Cutting l. [mm]	L [mm]	< [°]	R1 [mm]	R2 [mm]	SØ [mm]	n max. [RPM]	€
3104.612	12,7	12,7	44,5	14			6	21.000	31,75
3104.812	12,7	12,7	44,5	14			8	21.000	31,75
3104.925	25,4	12,7	44,5	14			12	21.000	47,20

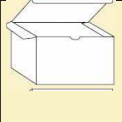
	Two carbide tipped cutting edges, side cutting and plunging		For milling groove joints, e.g. teeth for corner joints or edges and grooves for longitudinal joints. Suitable for all kinds of solid wood, wooden and laminated materials and some plastics. Manual and mechanical feed is allowed
	TCT (cutting edges)		To extend service life we recommend pre-cutting with a straight bit (e.g. product line 3107). For producing tear free corner joints we recommend clamping a piece of wood under the workpiece. Before unclamping your workpiece make sure that all teeth are exactly milled out
	Individually for each router bit, see product parameter		packing unit = 1, SB packaging



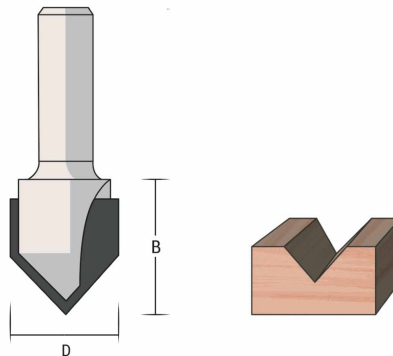

3105

 Excellent

V Groove Bit, two Flutes

FAMAG
...für Besserbohrer

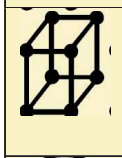
Art.- No.	D [mm]	Cutting l. [mm]	L [mm]	< [°]	R1 [mm]	R2 [mm]	SØ [mm]	n max. [RPM]	€
3105.660	12,7	16	44,5	60			6	21.000	31,75
3105.690	12,7	12,7	51	90			6	21.000	31,75
3105.860	12,7	16	44,5	60			8	21.000	31,75
3105.890	12,7	12,7	51	90			8	21.000	31,75

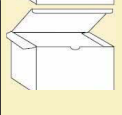
	Two carbide tipped cutting edges, side cutting and plunging. Available with angle of cutting edges of 60° and 90°		For milling V-shaped grooves, ornamental grooves or for chamfering edges. Suitable for all kinds of solid wood, wooden and laminated materials and some plastics. Manual and mechanical feed is allowed
	TCT (cutting edges)		The perfect router bit for exact and sharp ornamental grooves in doors and fronts of drawers
	Individually for each router bit, see product parameter		packing unit = 1, SB packaging

Technical changes or mistakes reserved! All prices are recommended retail prices additionally value added tax.



3155

 Excellent

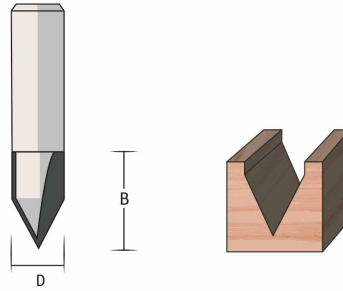
Solid Carbide Engraving Bit, three Flutes

FAMAG
 ...für Besserbohrer®

Art.-No.	D [mm]	Cutting l. [mm]	L [mm]	< [°]	R1 [mm]	R2 [mm]	SØ [mm]	n max. [RPM]	€
3155.660	14	22	57	60			6	21.000	79,10
3155.860	14	22	57	60			8	23.000	79,10

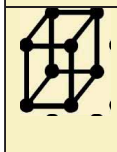
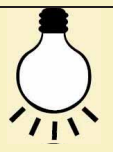
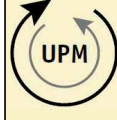
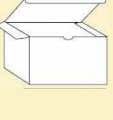
	Head with three cutting edges of solid carbide. Angle of cutting edges 60°, plunging version		For engraving letters of different width and milling of V-shaped grooves with an angle of 60°
	Head of solid carbide		Applicable for a cutting depth up to 13 mm maximum and a groove width up to 14 mm
	Individually for each router bit, see product parameter		packing unit = 1, SB packaging

3154





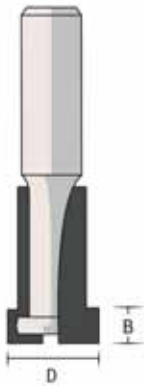

 Excellent

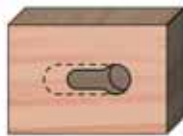
Keyhole Bit, one Flute

FAMAG
 ...für Besserbohrer®

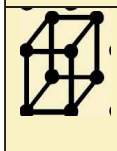
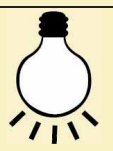
Art.-No.	D [mm]	Cutting l. [mm]	L [mm]	< [°]	R1 [mm]	R2 [mm]	SØ [mm]	n max. [RPM]	€
3154.609	9,8	5	38				6	22.000	24,80
3154.809	9,8	5	38				8	24.000	24,80

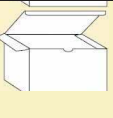

	One carbide tipped cutting edge parallel to the axis, side cutting and plunging		For cutting slots for hanging pictures, mirrors, shelves and so on. Suitable for all kinds of solid wood, wooden and laminated materials and some plastics. Manual and mechanical feed is allowed
	TCT (cutting edge)		If you want to fix an object at one point only, cut the slot vertically so that you can exactly balance the object sidewise
	Individually for each router bit, see product parameter		packing unit = 1, SB packaging

Technical changes or mistakes reserved! All prices are recommended retail prices additionally value added tax.

3106





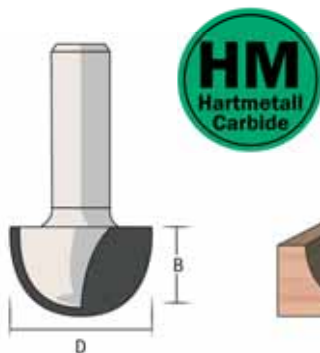

Excellent

Core Box Bit (Round Nose), two Flutes

FAMAG[®]
...für Besserbohrer[®]

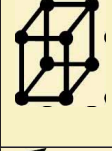
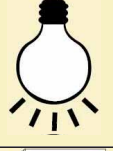
Art.- No.	D [mm]	Cutting l. [mm]	L [mm]	< [°]	R1 [mm]	R2 [mm]	SØ [mm]	n max. [RPM]	€
3106.609	9,5	6,4	38		4,8		6	22.000	37,55
3106.612	12,7	9,5	38		6,4		6	21.000	40,35
3106.615	15,9	9,5	40		7,9		6	19.000	42,45
3106.809	9,5	6,4	38		4,8		8	22.000	37,55
3106.812	12,7	9,5	38		6,4		8	21.000	40,35
3106.815	15,9	9,5	40		7,9		8	19.000	42,45
3106.819	19,1	12,7	40		9,5		8	18.000	49,15
3106.825	25,4	16	46,5		12,7		8	17.000	53,55

	Two carbide tipped cutting edges, side cutting and plunging		For milling chamfers, ornamental grooves and inside radii into the front of drawers and other surfaces. Suitable for all kinds of solid wood, wooden and laminated materials and some plastics. Manual feed is allowed
	TCT (cutting edges)		For exact and tear free chamfers we recommend a first flat cutting run and a second run to finish the groove tear free
	Individually for each router bit, see product parameter		packing unit = 1, SB packaging

3131







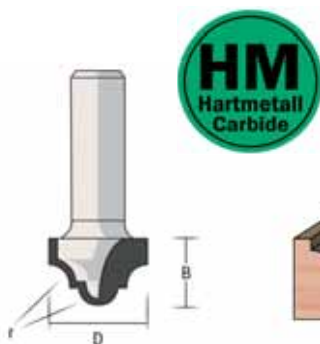

Excellent

Classical Bit, Plunge Type, two Flutes

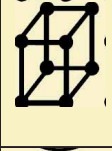
FAMAG[®]
...für Besserbohrer[®]

Art.- No.	D [mm]	Cutting l. [mm]	L [mm]	< [°]	R1 [mm]	R2 [mm]	SØ [mm]	n max. [RPM]	€
3131.612	12,7	10,5	51		2,5	3,5	6	20.000	69,15
3131.812	12,7	10,5	51		2,5	3,5	8	20.000	69,15

	Two carbide tipped cutting edges, with inner radius. Side cutting and plunging		For milling moulded grooves and edges. Suitable for all kinds of solid wood, wooden and laminated materials and some plastics. Manual feed is allowed
	TCT (cutting edges)		Perfect for ornamenting fronts of wardrobes and drawers. Due to the bit's detailed configuration, a particularly graceful moulding is possible
	Individually for each router bit, see product parameter		packing unit = 1, SB packaging

3137





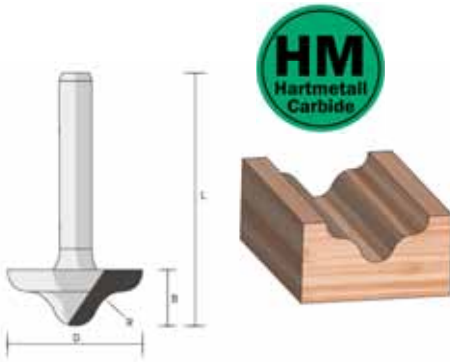

Excellent

Ogee Bit, Plunge Type, two Flutes

FAMAG[®]
...für Besserbohrer[®]

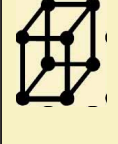
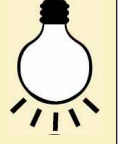
Art.- No.	D [mm]	Cutting l. [mm]	L [mm]	< [°]	R1 [mm]	R2 [mm]	SØ [mm]	n max. [RPM]	€
3137.827	27	11,2	51		6		8	17.000	73,40

	Two carbide tipped cutting edges. Side cutting and plunging		For milling moulded grooves. Suitable for all kinds of solid wood, wooden and laminated materials and some plastics. Manual feed is allowed
	TCT (cutting edges)		Perfect for ornamenting fronts of wardrobes and drawers. Due to the two radii without edges, you obtain particularly pleasing curves without folds
	Individually for each router bit, see product parameter		packing unit = 1, SB packaging

3127





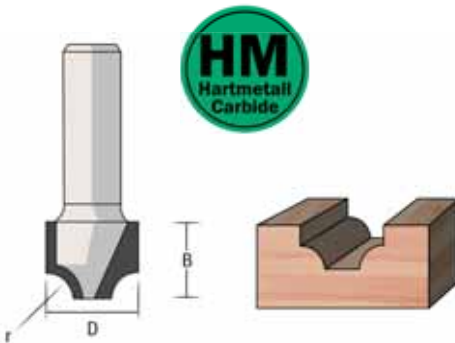

Excellent

Beading Bit, Plunge Type, two Flutes

FAMAG[®]
...für Besserbohrer[®]

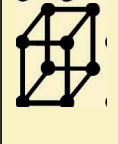
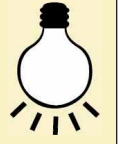
Art.- No.	D [mm]	Cutting l. [mm]	L [mm]	< [°]	R1 [mm]	R2 [mm]	SØ [mm]	n max. [RPM]	€
3127.609	9,5	7	51		2,5		6	24.000	44,00
3127.809	9,5	7	51		2,5		8	24.000	44,00

	Two carbide tipped cutting edges, with inner radius. Side cutting and plunging		For milling moulded grooves. Suitable for all kinds of solid wood, wooden and laminated materials and some plastics. Manual feed is allowed
	TCT (cutting edges)		Perfect for ornamenting fronts of wardrobes and drawers. Due to the two radii without edges, you obtain particularly pleasing curves without folds
	Individually for each router bit, see product parameter		packing unit = 1, SB packaging

Technical changes or mistakes reserved! All prices are recommended retail prices additionally value added tax.

3101





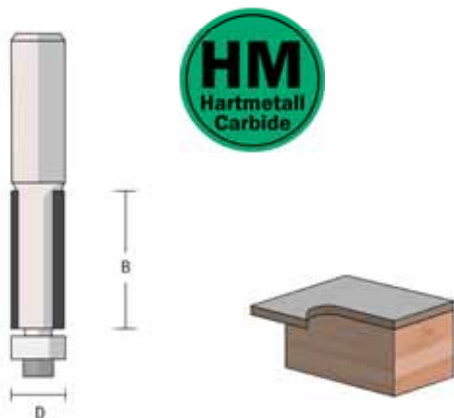

Excellent

Flush Trim Bit, two Flutes

FAMAG[®]
...für Besserbohrer[®]

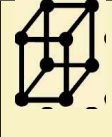
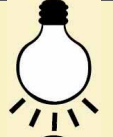
Art.- No.	D [mm]	Cutting l. [mm]	L [mm]	< [°]	R1 [mm]	R2 [mm]	SØ [mm]	n max. [RPM]	€
3101.612	12,7	12,7	60				6	21.000	26,60
3101.625	12,7	25,4	70				6	21.000	33,05
3101.895	9,52	25,4	70				8	21.000	33,05
3101.812	12,7	12,7	60				8	21.000	26,60
3101.825	12,7	25,4	70				8	21.000	33,05
3101.819	19,05	25,4	70				8	21.000	42,00

	Two carbide tipped side cutting edges parallel to the axis. With changeable ball bearing guide (Ø 12.7 mm) on front side		For copying to template, as well as for flush cutting and formatting of plastic and veneered edges. Suitable for all kinds of solid wood, wooden and laminated materials and some plastics. Manual feed is allowed
	TCT (cutting edges)		Perfect for cutting continuous holes into thicker boards. Mill the desired outline with a plunging router bit underneath the bord. Drill through the board (min Ø 14 mm) and trim the prefab contour on the top side flush
	Individually for each router bit, see product parameter		packing unit = 1, SB packaging

3114





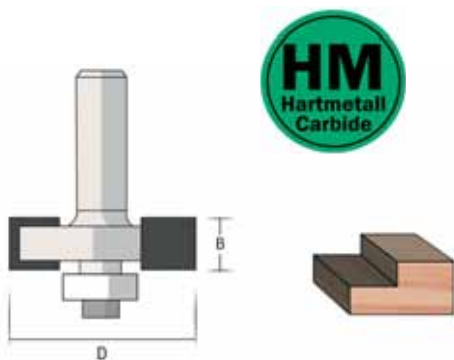

Excellent

Rabbeting Bit, two Flutes

FAMAG[®]
...für Besserbohrer[®]

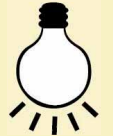
Art.- No.	D [mm]	Cutting l. [mm]	L [mm]	< [°]	R1 [mm]	R2 [mm]	SØ [mm]	n max. [RPM]	€
3114.631	31,7	12,7	51				6	16.000	59,75
3114.831	31,7	12,7	51				8	18.000	59,75

	Two carbide tipped side cutting edges with positive angle of cutting edges. With changeable ball bearing guide (Ø 12.7 mm). For depth of rabbets of 9.5 mm		For producing rabbeted joints of frames, embedding of doors and fronts of drawers, rabbeting of old wooden windows and embedding of insulation glass. Suitable for all kinds of solid wood, wooden and laminated materials and some plastics. Manual feed is allowed
	TCT (cutting edges)		Due to the ground front side of the edge very good surfaces of the rabbets are achieved. A rabbet depth of 11.1 mm can be achieved by mounting the ball bearing guide 3119.004 (please order separately)
	Individually for each router bit, see product parameter		packing unit = 1, SB packaging

3110





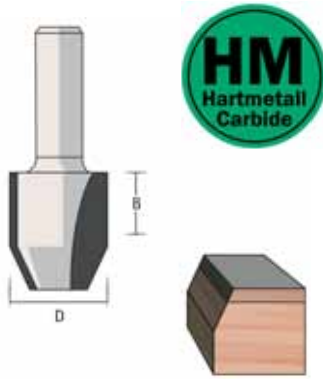

Excellent

Combination: Bevel and Flush Trim Bit

FAMAG®
...für Besserbohrer®

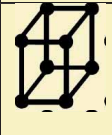
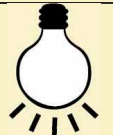
Art.- No.	D [mm]	Cutting l. [mm]	L [mm]	< [°]	R1 [mm]	R2 [mm]	SØ [mm]	n max. [RPM]	€
3110.812	12,7	12,7	41	30			8	22.000	29,90
3110.612	12,7	12,7	41	30			6	20.000	29,90

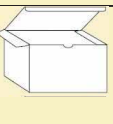
	Two carbide tipped side cutting edges. Angle of chamfering 30°		For cutting, flush milling and chamfering with one router bit only: cutting and flush milling with the cutting edge which is parallel to the axis, afterwards chamfering with an angle of 30° by adjusting the milling depth. Suitable for all kinds of solid wood, wooden and laminated materials and some plastics. Manual feed is allowed
	TCT (cutting edges)		Executing several worksteps with the same tool helps you to save tooling time
	Individually for each router bit, see product parameter		packing unit = 1, SB packaging

3115





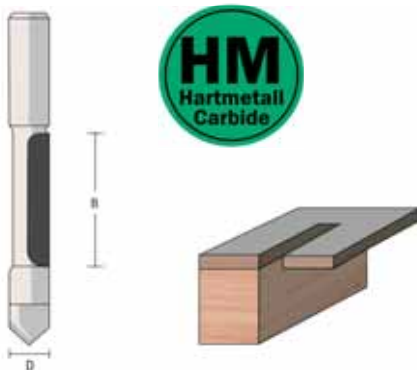

Excellent

Panel Pilot Bit with Drilling Point, one Flute

FAMAG®
...für Besserbohrer®

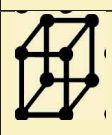
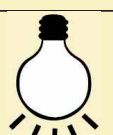
Art.- No.	D [mm]	Cutting l. [mm]	L [mm]	< [°]	R1 [mm]	R2 [mm]	SØ [mm]	n max. [RPM]	€
3115.606	6,4	19	63,5				6	28.000	28,70
3115.806	6,4	19	63,5				8	30.000	28,70

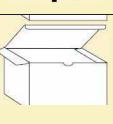
	With one carbide tipped side cutting edge and one not carbide tipped drilling edge		For flush milling of veneers and laminated edges of a workpiece. Suitable for all kinds of solid wood, wooden and laminated materials and some plastics. Manual and mechanical feed is allowed
	TCT (cutting edge)		With a simple template you can easily produce openings for e.g. wall sockets, switches and lamps in wooden ceilings and panels
	Individually for each router bit, see product parameter		packing unit = 1, SB packaging

Technical changes or mistakes reserved! All prices are recommended retail prices additionally value added tax.

3118





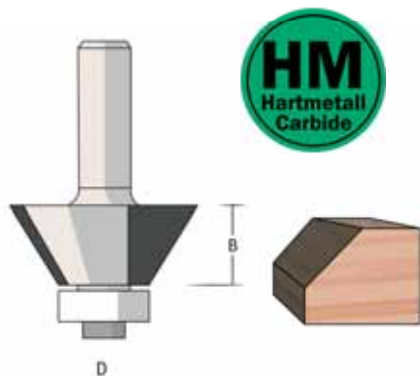

Excellent

Chamfer Bit, two Flutes

FAMAG[®]
...für Besserbohrer[®]

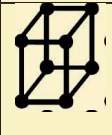
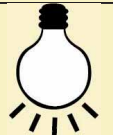
Art.- No.	D [mm]	Cutting l. [mm]	L [mm]	< [°]	R1 [mm]	R2 [mm]	SØ [mm]	n max. [RPM]	€
3118.645	31,8	12,7	53	45			6	15.000	46,45
3118.845	31,8	12,7	53	45			8	16.000	46,45
3118.836	36	12,7	53	45			8	16.000	46,45

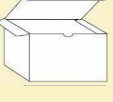
	Two carbide tipped side cutting edges parallel to the axis. Angle of cutting edge 45°. With changeable ball bearing guide (Ø 9.5 mm) on front side		For chamfering and milling edges in different strenghts on all stripes, made of solid wood, wooden and laminated materials and some plastics. Manual feed is allowed
	TCT (cutting edges)		For milling chamfers with an angle of 15° we recommend our bevel trim bit product line 3102
	Individually for each router bit, see product parameter		packing unit = 1, SB packaging

3102





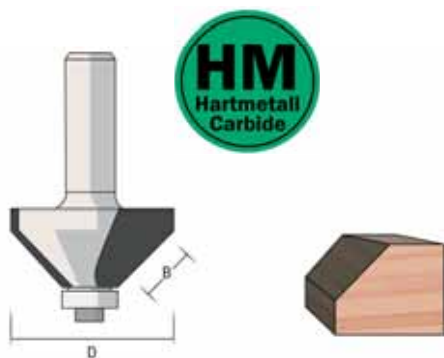

Excellent

Bevel Trim Bit, two Flutes

FAMAG[®]
...für Besserbohrer[®]

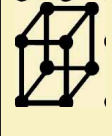
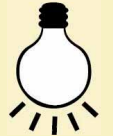
Art.- No.	D [mm]	Cutting l. [mm]	L [mm]	< [°]	R1 [mm]	R2 [mm]	SØ [mm]	n max. [RPM]	€
3102.615	15,9	6,4	52,4	15			6	19.000	27,30
3102.815	15,9	6,4	52,4	15			8	19.000	27,30

	Two carbide tipped side cutting edges parallel to the axis. With changeable ball bearing guide (Ø 12.7 mm) on front side		For professional chamfering and milling of edges. Suitable for all kinds of solid wood, wooden and laminated materials and some plastics. Manual feed is allowed
	TCT (cutting edges)		Edges, which are worn off during permanent use (e.g. legs of chairs or tables), can be furnished with a proper and non-sensitive chamfer
	Individually for each router bit, see product parameters		packing unit = 1, SB packaging

3109





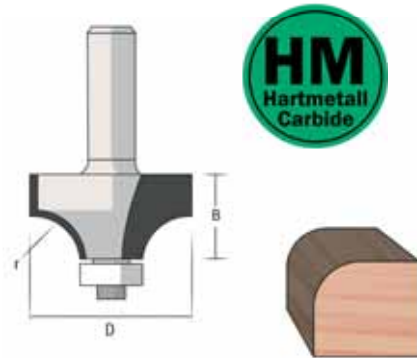

Excellent

Rounding Over Bit, two Flutes

FAMAG®
...für Besserbohrer®

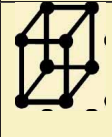
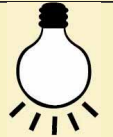
Art.- No.	D [mm]	Cutting l. [mm]	L [mm]	< [°]	R1 [mm]	R2 [mm]	SØ [mm]	n max. [RPM]	€
3109.616	16,7	9,5	49	2	2		6	19.000	
3109.618	18,7	9,5	49	3	3		6	19.000	57,50
3109.625	25,4	12,7	51	6,4	6,4		6	17.000	59,50
3109.628	28,6	12,7	51	8	8		6	17.000	61,00
3109.631	31,8	15,9	55,5	9,5	9,5		6	16.000	66,45
3109.816	16,7	9,5	49	2	2		8	19.000	57,45
3109.818	18,7	9,5	49	3	3		8	19.000	57,50
3109.819	20,7	9,5	49	4	4		8	18.000	57,50
3109.825	25,4	12,7	51	6,4	6,4		8	17.000	59,50
3109.828	28,6	12,7	51	8	8		8	17.000	61,00
3109.831	31,8	15,9	55,5	9,5	9,5		8	16.000	66,45
3109.832	32,7	16	55,5	10	10		8	16.000	69,55
3109.838	38,1	19,1	57	12,7	12,7		8	16.000	71,20
3109.844	44,5	22	64	15,9	15,9		8	16.000	84,50

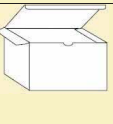
	Two carbide tipped side cutting edges. With changeable ball bearing guide (Ø 12.7 mm) on front side		For producing outer radii on edges of workpieces. Suitable for all kinds of solid wood, wooden and laminated materials and some plastics. Manual feed is allowed
	TCT (cutting edges)		For producing covings with below located chamfer, we recommend our product line 3119
	Individually for each router bit, see product parameter		packing unit = 1, SB packaging

3119





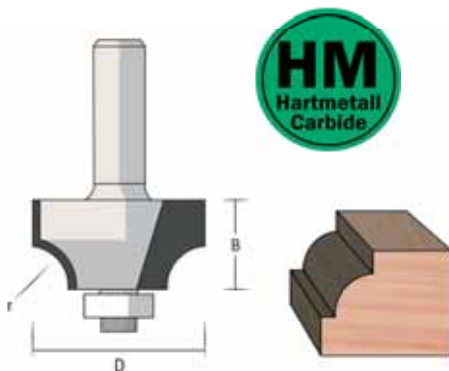

Excellent

Beading Bit, two Flutes

FAMAG®
...für Besserbohrer®

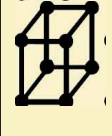
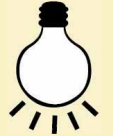
Art.- No.	D [mm]	Cutting l. [mm]	L [mm]	< [°]	R1 [mm]	R2 [mm]	SØ [mm]	n max. [RPM]	€
3119.625	25,4	12,7	51	6,4	6,4		6	17.000	59,50
3119.628	28,6	12,7	51	7,9	7,9		6	16.000	61,00
3119.631	31,8	15,9	55,5	9,5	9,5		6	16.000	66,45
3119.819	19,1	9,5	47,5	4	4		8	18.000	57,50
3119.825	25,4	12,7	51	6,4	6,4		8	17.000	59,50
3119.828	28,6	12,7	51	7,9	7,9		8	16.000	61,00
3119.831	31,8	15,9	55,5	9,5	9,5		8	16.000	66,45
3119.838	38,1	19,1	57	12,7	12,7		8	15.000	71,20

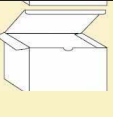
	Two carbide tipped side cutting edges with inner radius. With changeable ball bearing guide (Ø 9.5 mm) on front side		For milling of typical covings or profiles with small fold edge. Suitable for all kinds of solid wood, wooden and laminated materials and some plastics. Manual feed is allowed
	TCT (cutting edges)		If you want to create a coving without fold edge, we recommend our rounding over bit product line 3109. Also you can simply exchange the ball bearing guide Ø 9.5 mm for a Ø 12.7 mm
	Individually for each router bit, see product parameter		packing unit = 1, SB packaging

Technical changes or mistakes reserved! All prices are recommended retail prices additionally value added tax.

3125

 Excellent

True Bull Nose Bit, two Flutes

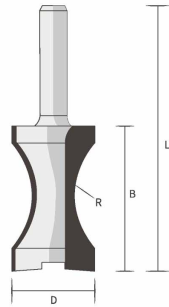
FAMAG®
...für Besserbohrer®

Art.- No.	D [mm]	Cutting l. [mm]	L [mm]	α [°]	R1 [mm]	R2 [mm]	SØ [mm]	n max. [RPM]	€
3125.820	20,2	32	62,6		18		8	18.000	101,90



Two carbide tipped side cutting edges parallel to the axis



For milling flat curves on stripes, edges and front of boards. Suitable for all kinds of solid wood, wooden and laminated materials and some plastics. Manual feed is allowed

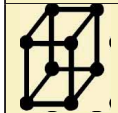

TCT (cutting edges)

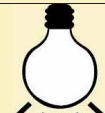

Boards thinner than 20 mm will have curves without rabbets. If the boards are thicker than 20 mm (up to maximum 30 mm) there will be a rabbet each lower side and on top

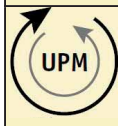

Individually for each router bit, see product parameter



packing unit = 1, SB packaging

3123

 Excellent

Bull Nose Bit (Half Round), two Flutes

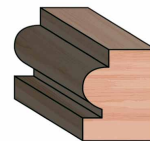
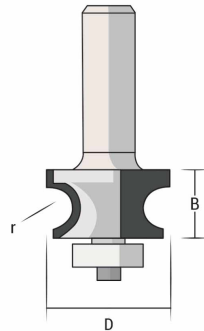
FAMAG®
...für Besserbohrer®

Art.- No.	D [mm]	Cutting l. [mm]	L [mm]	α [°]	R1 [mm]	R2 [mm]	SØ [mm]	n max. [RPM]	€
3123.828	28,2	16	57		4,8		8	17.000	70,55



Two carbide tipped side cutting edges with inner radius of 4,8 mm. With changeable ball bearing guide (Ø 16 mm) on front side



For milling traditional corners and edges. Suitable for all kinds of solid wood, wooden and laminated materials and some plastics. Manual feed is allowed

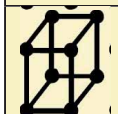

TCT (cutting edges)

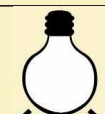

In two work steps you can produce a complete ornamental edge

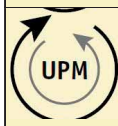

Individually for each router bit, see product parameter

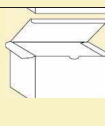

packing unit = 1, SB packaging

Technical changes or mistakes reserved! All prices are recommended retail prices additionally value added tax.



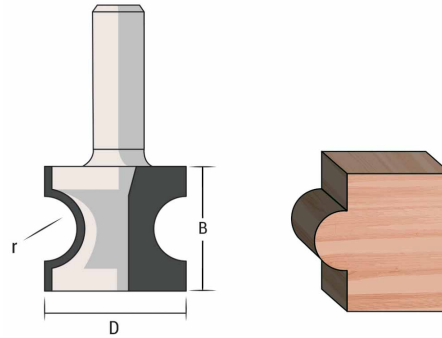

3124

 Excellent

Bull Nose Bit (Half Round), two Flutes

FAMAG
...für Besserbohrer

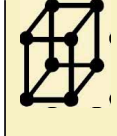
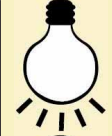
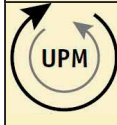
Art.- No.	D [mm]	Cutting l. [mm]	L [mm]	< [°]	R1 [mm]	R2 [mm]	SØ [mm]	n max. [RPM]	€
3124.822	22,2	19,1	47,6		5,2		8	18.000	87,35

	Two carbide tipped side cutting edges parallel to the axis, with inner radius of 5.2 mm		For milling half round edges on window sills, frames and stairrails. Suitable for all kinds of solid wood, wooden and laminated materials and some plastics. Manual feed is allowed
	TCT (cutting edges)		Strip should have a minimum thickness of 10.4 mm. If you want to mill a radius with two rabbets you should use strips up to 19 mm thickness
	Individually for each router bit, see product parameter		packing unit = 1, SB packaging



3112

 Excellent

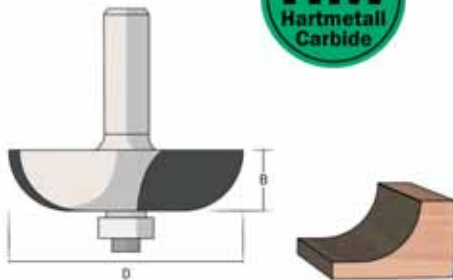
Cove Bit, two Flutes

FAMAG
...für Besserbohrer

Art.- No.	D [mm]	Cutting l. [mm]	L [mm]	< [°]	R1 [mm]	R2 [mm]	SØ [mm]	n max. [RPM]	€
3112.625	25,4	14,3	55		7,9		6	17.000	61,00
3112.822	22,2	14,3	55		6,4		8	18.000	59,50
3112.825	25,5	14,4	55		8		8	17.000	61,00
3112.834	34,9	16	54		12,7		8	16.000	71,15

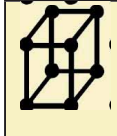
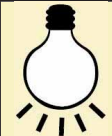
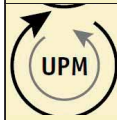
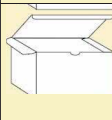
	Two carbide tipped side cutting edges parallel to the axis. With changeable ball bearing guide (Ø 9.5 mm) on front side		For milling end strips, fronts of drawers, cabinet doors and all ornamental edges with inner radius. Suitable for all kinds of solid wood, wooden and laminated materials and some plastics. Manual feed is allowed
	TCT (cutting edges)		Ideal in combination with rounding over bit product line 3109 with respective radius 6, 8 and 12,7 mm
	Individually for each router bit, see product parameter		packing unit = 1, SB packaging

Technical changes or mistakes reserved! All prices are recommended retail prices additionally value added tax.



3148

 Excellent

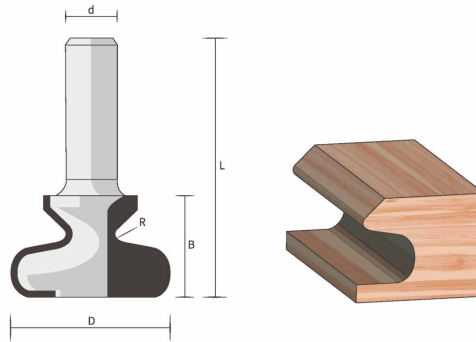
Finger Grip Router Bit, two Flutes

FAMAG
 ...für Besserbohrer®

Art.- No.	D [mm]	Cutting l. [mm]	L [mm]	α [°]	R1 [mm]	R2 [mm]	SØ [mm]	n max. [RPM]	€
3148.819	19,1	19	55,6		4,8		8	19.000	89,70

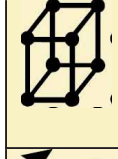
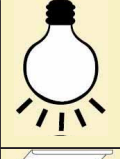
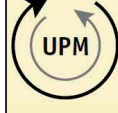
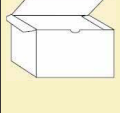
	Two carbide tipped side cutting edges		For milling profiles, grooves and handle strips. Suitable for all kinds of solid wood, wooden and laminated materials and some plastics. Manual feed is allowed
	TCT (cutting edges)		
	Individual for each router bit, see product parameter		packing unit = 1, SB packaging



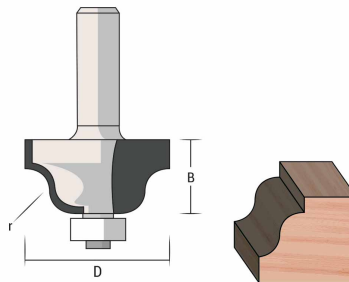

3113

 Excellent

Roman Ogee Bit, two Flutes

FAMAG
 ...für Besserbohrer®

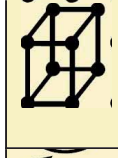
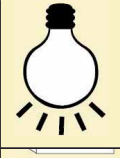
Art.- No.	D [mm]	Cutting l. [mm]	L [mm]	α [°]	R1 [mm]	R2 [mm]	SØ [mm]	n max. [RPM]	€
3113.625	25,4	16	54		4		6	17.000	63,00
3113.825	25,4	16	54		4		8	17.000	63,00
3113.834	34,9	20	57		6,4		8	16.000	69,65

	Two carbide tipped side cutting edges. With changeable ball bearing guide (Ø 9.5 mm) on front side		For milling ornamental strips on picture frames, table edges, fronts of wardrobes, drawer elements, baseboards and so on. Suitable for all kinds of solid wood, wooden laminated materials and some plastics. Manual feed is allowed
	TCT (cutting edges)		In order to receive good milling results, i.e., proper and tear free profiles, we recommend milling in several worksteps
	Individually for each router bit, see product parameter		packing unit = 1, SB packaging

Technical changes or mistakes reserved! All prices are recommended retail prices additionally value added tax.

3138

Excellent

Panelling Bit, two Flutes

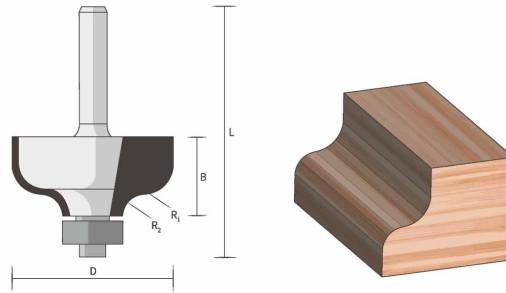
FAMAG[®]
...für Besserbohrer[®]

Art.- No.	D [mm]	Cutting l. [mm]	L [mm]	< [°]	R1 [mm]	R2 [mm]	SØ [mm]	n max. [RPM]	€
3138.834	34,9	17,5	55,6		6	5	8	16.000	90,50

	Two carbide tipped side cutting edges. With changeable ball bearing guide (Ø 12.7 mm) on front side		For milling ornamental strips on picture frames, table edges, fronts of wardrobes, drawer elements, baseboards etc. Suitable for all kinds of solid wood, wooden laminated materials and some plastics. Manual feed is allowed
	TCT (cutting edges)		Particularly suitable for ornamenting fronts of wardrobes and drawers. Due to the two ground radii without edges, you receive very compliant curves without rabbets
	Individually for each router bit, see product parameter		packing unit = 1, SB packaging

3139

Excellent

Classic Panel Bit, with 2 Flutes

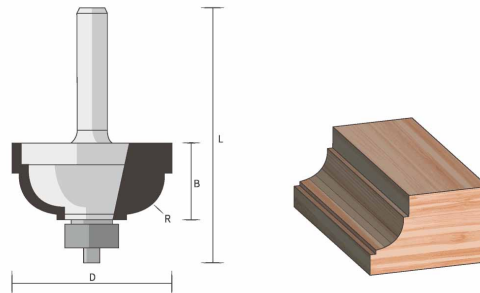
FAMAG[®]
...für Besserbohrer[®]

Art.- No.	D [mm]	Cutting l. [mm]	L [mm]	< [°]	R1 [mm]	R2 [mm]	SØ [mm]	n max. [RPM]	€
3139.628	28,6	12,7	51		4,8		6	16.000	78,00
3139.828	28,6	12,7	51		4,8		8	16.000	78,00

	Two carbide tipped side cutting edges. With changeable ball bearing guide (Ø 12.7 mm) on front side		For milling ornamental strips on picture frames, table edges, fronts of wardrobes, drawer elements, baseboards etc. Suitable for all kinds of solid wood, wooden laminated materials and some plastics. Manual feed is allowed
	TCT (cutting edges)		If you want to cut a chamfer without rabbets, we recommend our cove bit product line 3112
	Individually for each router bit, see product parameter		packing unit = 1, SB packaging

Technical changes or mistakes reserved! All prices are recommended retail prices additionally value added tax.

3134

Excellent

Roman Ogee Bit, two Flutes

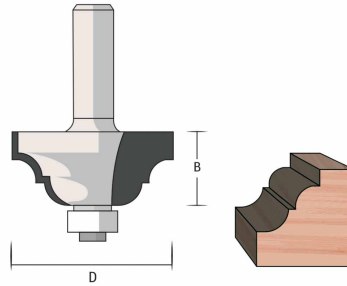
FAMAG[®]
...für Besserbohrer[®]

Art.- No.	D [mm]	Cutting l. [mm]	L [mm]	α [°]	R1 [mm]	R2 [mm]	SØ [mm]	n max. [RPM]	€
3134.625	25,4	16	54		4		6	17.000	69,75
3134.825	25,4	16	54		4		8	17.000	69,75
3134.834	34,9	20	57		6,35		8	16.000	71,20

	Two carbide tipped side cutting edges. With changeable ball bearing guide (Ø 9.5 mm) on front side		For milling ornamental strips on picture frames, table edges, fronts of wardrobes, drawer elements, baseboards etc. Suitable for all kinds of solid wood, wooden laminated materials and some plastics. Manual feed is allowed
	TCT (cutting edges)		In order to receive good milling results, i.e., proper and tear free profiles, we recommend milling in several worksteps
	Individually for each router bit, see product parameter		packing unit = 1, SB packaging

3121

Excellent

Ogee Fillet Bit, two Flutes

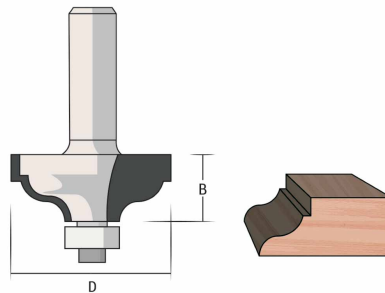
FAMAG[®]
...für Besserbohrer[®]

Art.- No.	D [mm]	Cutting l. [mm]	L [mm]	α [°]	R1 [mm]	R2 [mm]	SØ [mm]	n max. [RPM]	€
3121.634	34,9	13,5	52,4		4	4	6	16.000	102,00
3121.834	34,9	13,5	52,4		4	4	8	17.000	102,00

	Two carbide tipped side cutting edges with two radii. With changeable ball bearing guide (Ø 12.7 mm) on front side		For milling decorative profiles on ornamental stripes, fronts of furniture, drawers and tabletops. Suitable for all kinds of solid wood, wooden laminated materials and some plastics. Manual feed is allowed
	TCT (cutting edges)		In order to receive smooth surfaces, we recommend milling in several worksteps
	Individually for each router bit, see product parameter		packing unit = 1, SB packaging

Technical changes or mistakes reserved! All prices are recommended retail prices additionally value added tax.



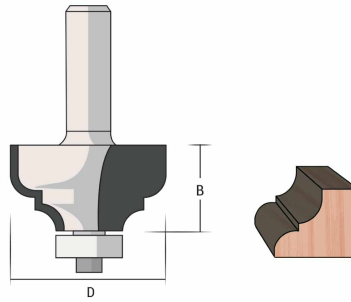

3135

 Excellent

Ogee Fillet Bit, two Flutes

FAMAG
...für Besserbohrer®

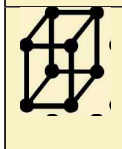
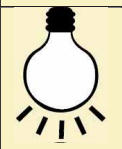
Art.- No.	D [mm]	Cutting l. [mm]	L [mm]	α [°]	R1 [mm]	R2 [mm]	SØ [mm]	n max. [RPM]	€
3135.834	34,9	17,5	56		6,4	5	8	16.000	102,15

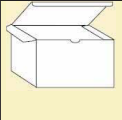
	Two carbide tipped side cutting edges. With changeable ball bearing guide (Ø 9.5 mm) on front side		For milling ornamental strips on picture frames, table edges, fronts of wardrobes, drawers, baseboards etc. Suitable for all kinds of solid wood, laminated materials and some plastics. Manual feed is allowed
	TCT (cutting edges)		In order to receive good milling results, i.e., proper and tear free profiles, we recommend milling in several worksteps
	Individually for each router bit, see product parameter		packing unit = 1, SB packaging



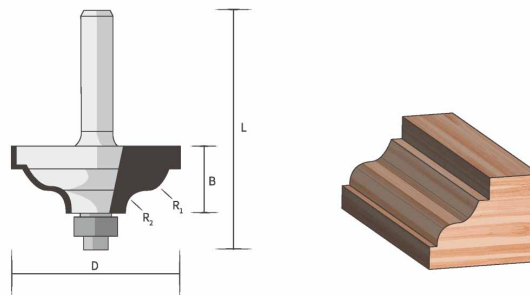

3122

 Excellent

Ogee Fillet Bit, two Flutes

FAMAG
...für Besserbohrer®

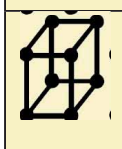
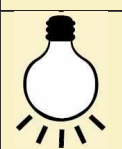
Art.- No.	D [mm]	Cutting l. [mm]	L [mm]	α [°]	R1 [mm]	R2 [mm]	SØ [mm]	n max. [RPM]	€
3122.634	34,9	13,5	52,4		4	4	6	16.000	102,00
3122.834	34,9	13,5	52,4		4	4	8	17.000	102,00

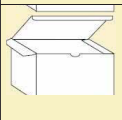
	Two carbide tipped side cutting edges with two radii. With changeable ball bearing guide (Ø 9.5 mm) on front side		For milling decorative profiles with rabbets on ornamental strips, fronts of furniture, drawers and tabletops. Suitable for all kinds of solid wood, laminated materials and some plastics. Manual feed is allowed
	TCT (cutting edges)		In order to receive smooth surfaces, we recommend milling in several worksteps. If you want to cut a profile without rabbet, we recommend our ogee fillet bit product line 3121 with ball bearing guide Ø 12.7 mm
	Individually for each router bit, see product parameter		packing unit = 1, SB packaging

Technical changes or mistakes reserved! All prices are recommended retail prices additionally value added tax.



3158

 Excellent

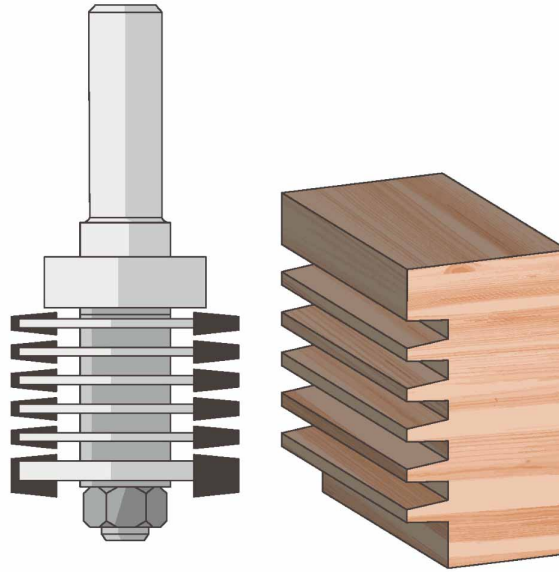
Finger Jointer Router Bit Set

FAMAG[®]
...für Besserbohrer[®]

Art.- No.	D [mm]	Cutting l. [mm]	L [mm]	\angle [°]	R1 [mm]	R2 [mm]	SØ [mm]	n max. [RPM]	€
3158.939	39,7						12	15.000	169,20

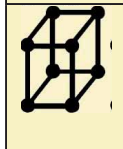
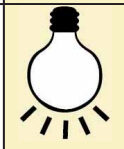
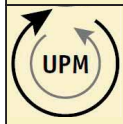
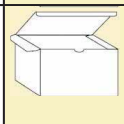
	<p>Consisting of shank with ball bearing guide (Ø 28 mm), spacers, washer, fastening nut and six carbide tipped slotting cutters, side cutting (router bit completely mounted)</p>		<p>Produce a geometry of slots with this router bit at the front surface of the connecting workpiece. The milled matching part can be glued firmly. Manual feed is allowed</p>
	<p>TCT (slotting cutters)</p>		<p>The created connections are especially solid due to the enhanced glue line and nearly invisible</p>
	<p>Individually for each router bit, see product parameter</p>		<p>packing unit = 1, SB packaging</p>

Technical changes or mistakes reserved! All prices are recommended retail prices additionally value added tax.

3217

Excellent

Straight Bit, Plunge, one Flute



Art.- No.	D [mm]	Cutting l. [mm]	OAL [mm]	SØ [mm]	TCT blade	n max. [RPM]	€
3217.932	12	30	77	12	3290.930	22.000	96,15
3217.936	16	30	88	12	3290.130	18.000	96,60
3217.956	16	50	107	12	3290.050	18.000	115,15
3217.938	18	30	88	12	3290.130	18.000	97,95
3217.958	18	50	107	12	3290.050	18.000	115,75
3217.940	20	30	88	12	3290.130	16.000	100,85
3217.960	20	50	107	12	3290.050	16.000	122,10

	One changeable carbide reversing blade, parallel to the axis, side cutting and plunging. The blade is configured as cutting bit		For grooving, cutting finger joints, rabbeting and creating of tongue and groove connections. Due to the carbide tipped front cutting edge, the bit can also be used for plunging. Suitable for all kinds of solid wood, wooden and laminated materials and some plastics
	High quality carbide reversing blade		Very long service life through multiple use of the reversing blades. Low downtimes as they are changed within a few minutes and a regrinding is not necessary. In case you do not want to use the bit for plunging, we recommend our product line 3227
	Individually for every router bit, see parameters of product		packing unit = 1, SB packaging

3227

Excellent

Straight Bit, no Plunge, two Flutes

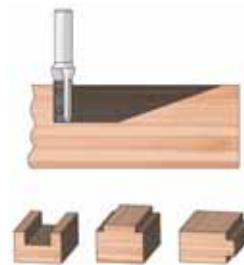

Art.- No.	D [mm]	Cutting l. [mm]	OAL [mm]	SØ [mm]	TCT blade	n max. [RPM]	€
3227.936	16	30	88	12	3290.930	20.000	118,40
3227.956	16	50	107	12	3290.930	18.000	139,30
3227.958	18	50	107	12	3290.130	18.000	142,80
3227.960	20	50	107	12	3290.130	16.000	148,15





	Two changeable carbide reversing blades, parallel to the axis, side cutting		For grooving, cutting finger joints, rabbeting and creating of tongue and groove connection. Suitable for all kinds of solid wood, wooden laminated materials and some plastics. Manual and mechanical feed are allowed
	High quality carbide reversing blade		Very long service life through multiple use of the reversing blades. Low downtimes as they are changed within a few minutes and a regrinding is not necessary
	Individually for each router bit, see product parameter		packing unit = 1, SB packaging

Technical changes or mistakes reserved! All prices are recommended retail prices additionally value added tax.

3207 **Excellent** **Straight Bit, Staggered, Plunge, two Flutes** **FAMAG®**
...für Besserbohrer®



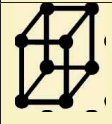

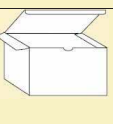

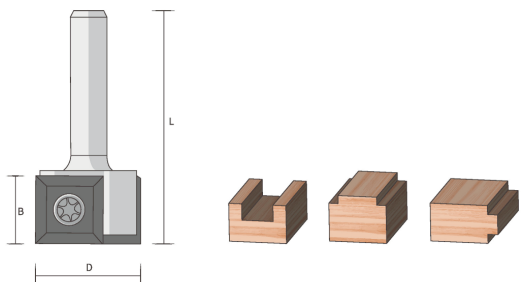

Art.- No.	D [mm]	Cutting l. [mm]	OAL [mm]	SØ [mm]	TCT blade	n max. [RPM]	€
3207.820	20	20	52	8	3290.012	22.000	108,85

	Two changeable carbide reversing blades, parallel to the axis, side cutting and plunging. The blades are arranged in an angle of 90°, one blade is configured as cutting bit		For grooving, cutting finger joints, rabbeting and creating of tongue and groove connections. Due to the carbide tipped front cutting edge, the bit can also be used for plunging. Suitable for all kinds of solid wood, wooden and laminated materials and some plastics
	High quality carbide reversing blade		Very long service life through multiple use of the reversing blades. Low downtimes as they are changed within a few minutes and a regrinding is not necessary. In case you do not want to use the bit for plunging, we recommend our product line 3203
	Individually for each router bit, see product parameter		packing unit = 1, SB packaging

3203 **Excellent** **Straight Bit, no Plunge, two Flutes** **FAMAG®**
...für Besserbohrer®

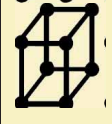
Art.- No.	D [mm]	Cutting l. [mm]	OAL [mm]	SØ [mm]	TCT blade	n max. [RPM]	€
3203.620	20	12	44	6	3290.012	22.000	89,55
3203.818	18	12	44	8	3290.012	24.000	87,10
3203.820	20	12	44	8	3290.012	24.000	89,55

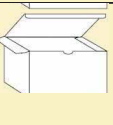
	Two changeable carbide reversing blades, parallel to the axis, side cutting		For grooving, cutting finger joints, rabbeting and creating of tongue and groove connection. Suitable for all kinds of solid wood, wooden laminated materials and some plastics. Manual and mechanical feed are allowed
	High quality carbide reversing blade		Very long service life through multiple use of the reversing blades. Low downtimes as they are changed within a few minutes and a regrinding is not necessary. In case you want to use the bit for plunging, we recommend our product line 3207
	Individually for each router bit, see product parameter		packing unit = 1, SB packaging

3201

Excellent

Flush Trim Bit, two Flutes

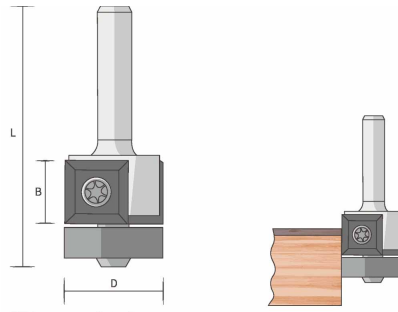

Art.- No.	D [mm]	Cutting l. [mm]	OAL [mm]	SØ [mm]	TCT blade	n max. [RPM]	€
3201.812	19	12	54	8	3290.012	24.000	94,55
3201.830	19	30	72	8	3290.030	24.000	111,75

	Two changeable carbide reversing blades, parallel to the axis, side cutting. With changeable ball bearing guide (Ø 19 mm) on front side		For chamfering and milling edges on all kinds of solid wood, laminated materials and some plastics. Manual feed is allowed
	High quality carbide reversing blade		Very long service life through multiple use of the reversing blades. Low downtimes as they are changed within a few minutes and a regrinding is not necessary
	Individually for each router bit, see product parameter		packing unit = 1, SB packaging

3202

Excellent

Bevel Trim Bit, two Flutes

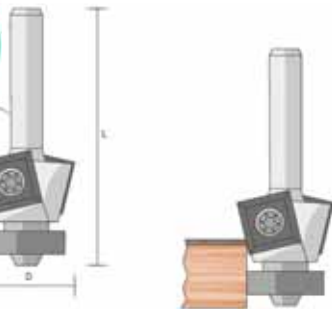



Art.- No.	D [mm]	Cutting l. [mm]	OAL [mm]	< [°]	SØ [mm]	TCT blade	n max. [RPM]	€
3202.645	27	12	57	45	6	3290.012	16.000	118,45
3202.815	20	12	55	15	8	3290.012	24.000	104,30
3202.845	27	12	57	45	8	3290.012	18.000	118,45

	Two changeable carbide reversing blades, parallel to the axis, side cutting. With changeable ball bearing guide (Ø 15,9 mm) on front side		For milling profiles, grooves and chamfers on nearly all kinds of solid wood, wooden and laminated materials and plastics, also CORIAN etc.
	High quality carbide reversing blade		Very long service life through multiple use of the reversing blades. Low downtimes as they are changed within a few minutes and a regrinding is not necessary
	Individually for each router bit, see product parameter		packing unit = 1, SB packaging

Technical changes or mistakes reserved! All prices are recommended retail prices additionally value added tax.

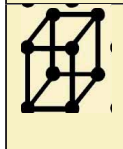
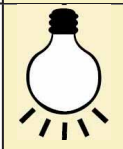
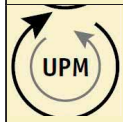
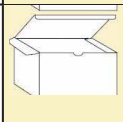

Art.- No.	Description	O-Ø [mm]	IØ [mm]	Height [mm]	€
3191.001	For item: 3112, 3113, 3118, 3134	9,5	3,2	4,0	12,50
3191.002	For item: 3201				
3191.003	For item: 3202				
3191.004	For item: 3119, 3122, 3135	9,5	4,8	3,0	13,85
3191.005	For item: 3157, 3202.615/630/815/830	15,9	6,4	5,0	13,85
3191.006	For item: 3202				
3191.007	For item: 3101, 3102, 3109, 3114, 3121, 3138, 3139	12,7	4,8	5,0	13,85
3191.010	For item: 3123	16,0	5,0	5,0	13,85
3191.114	For item: 3202.645/845	12,7	6,4	5,8	16,10
3191.113	For item: 3201	19	6	6	14,50

	Premium ball bearing with attachment screw and spacer (not for reversing blade router bits)		Suitable for all FAMAG router bits and bevel trimming bits with ball bearing guide. Please pay attention whether you order the bearing for using it with a router / bevel trimming bit
			Please use only FAMAG ball bearings for FAMAG router bits
	Individually for each router bit, see product parameter		packing unit = 1, SB packaging



3290

 Excellent

Reversing blade carbide

FAMAG®
...für Besserbohrer®

Art.- No.	Description	Cutting l. [mm]	Height [mm]	thickness [mm]	Torx-Schr.	€
3290.012	four-toothed	12	12	1,5	3291.040	5,65
3290.030	two-toothed	12	30	1,5	3291.040	7,30
3290.050	four-toothed	12	50	1,5	3291.035	13,95
3290.130	four-toothed	12	30	1,5	3291.035	13,70
3290.930	four-toothed	9	30	1,5	3291.035	7,20

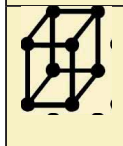
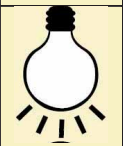
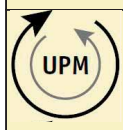
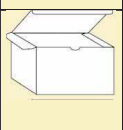
	High quality reversing blades of carbide for the exchange of FAMAG insert cutters		Use only the original inserts for the FAMAG-insert cutters, that'll save time and trouble
	High quality reversing blades of carbide		These reversing blades are specifically designed for the FAMAG cutters with indexable inserts and are simply the best fit
	Individually for every router bit, see parameters of product		packing unit = 1, Rose tube

3195

 Excellent

Allen Key and Screws for Ball Bearings Product Line 3191

FAMAG®
...für Besserbohrer®

Allen key for router bits





Art.- No.	Description	SW [Inch]	Wrench size [mm]	€
3195.332	appropriate for item number: 3191.004, 3191.007	3/32"	2,38	5,65

Torx key for Flush trimming bits

Art.- No.	Description	Wrench size [mm]	€
3295.015	appropriate for all mentioned item numbers	T15	7,55

Torx screw for Flush trimming bits

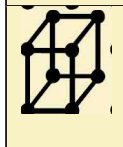
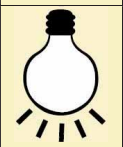
Art.- No.	Description	Wrench size [mm]	€
3291.035	suitable for reversing blade, carbide, 3290.050 / 3290.130 / 3290.930	M 3,5	3,95
3291.040	suitable for reversing blade, carbide, 3290.012 / 3290.030	M 4	2,95

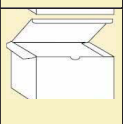
	Wrenches		Suitable for all FAMAG ball bearings product line 3191
	Chrome Vanadium steel		Only the wrench 3195.332 fits into the hexagon socket screw (5/64")
			packing unit = 1, SB packaging

Technical changes or mistakes reserved! All prices are recommended retail prices additionally value added tax.



Drills and Countersinks for Metal

105





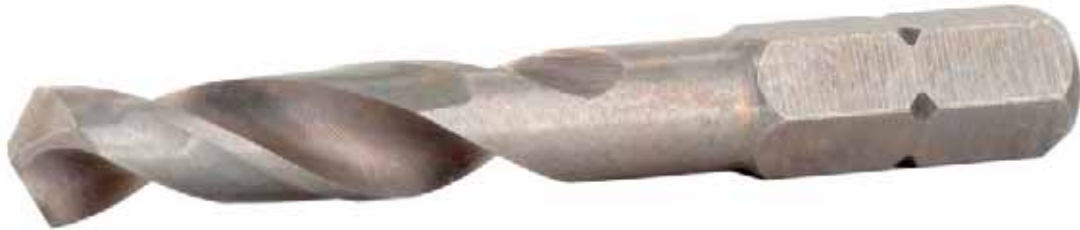

Twist Drill Bit, HSS-G, Short Version	106
Right-Angle-Driver 90fix	108
Twist Drill, DIN 338, HSS-G Ti Nitrified	109
Twist Drill, DIN 338, HSS-G	110
Twist Drill, DIN 338, HSS-G Co	112
Twist Drill, DIN 340, HSS-G Co	114
Twist Drill, DIN 1869, HSS-G Co	115
Twist Drill, HSS-G, Long Version	117
Drill and Milling Cutter, HSS	118
Twist Drill, Double Sided, HSS-G	118
Countersink, HSS	119
Hole Enlarger, HSS	120
Step Drill, HSS	120



Art.- No.	O-Ø [mm]	Shank [mm]	OAL [mm]	SpL [mm]	€
2596.030	3	C 6,3	38	16	7,10
2596.033	3,3	C 6,3	40	18	7,10
2596.035	3,5	C 6,3	40	18	7,10
2596.040	4	C 6,3	44	20	7,10
2596.042	4,2	C 6,3	46	24	7,30
2596.045	4,5	C 6,3	46	24	7,30
2596.050	5	C 6,3	50	26	7,30
2596.055	5,5	C 6,3	50	26	7,80
2596.060	6	C 6,3	50	26	7,80
2596.065	6,5	C 6,3	50	30	7,80
2596.068	6,8	C 6,3	50	30	7,80
2596.070	7	C 6,3	50	30	7,80
2596.075	7,5	C 6,3	51	32	9,80
2596.080	8	C 6,3	51	32	9,80
2596.085	8,5	C 6,3	53	33	10,60
2596.090	9	C 6,3	53	33	12,00
2596.100	10	C 6,3	54	38	12,00

Sets

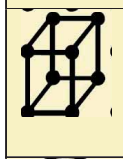
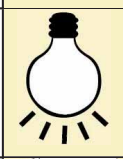
Art.- No.	Description	€
2596.805	Set of 5 pieces in plastic box Ø 3, 4, 5, 6, 8 mm	34,90
2596.508	Set of 9 pieces in wooden case Ø 3, 4, 5, 6, 7, 8, 9, 10 mm and bitholder	66,85

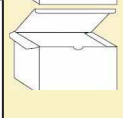

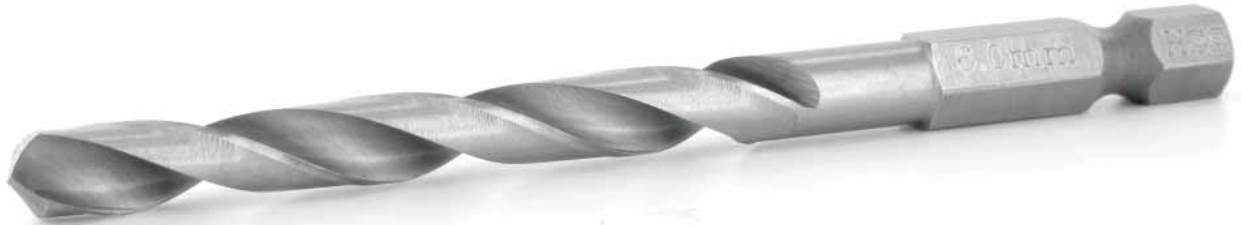

	<p>One-piece twist drill bit, fully ground from the solid, short version with hexagonal shank for bit holder (1/4"; C 6,3), polished section of the surface of the cone 118°, blank ground</p>		<p>For drilling alloyed and not alloyed steel and cast steel up to 900 N/mm², grey and malleable cast iron etc., with a cordless screwdriver. The ground chip flutes guarantee a good chip removal</p>
	<p>HSS-G</p>		<p>It is recommended to use lockable bit holders to avoid the drill bit getting jammed in the drill hole</p>
	<p>Relevant diagram respectively cordless screwdriver</p>		<p>packing unit = 1, PE tube</p>



Art.- No.	O-Ø [mm]	SØ [mm]	OAL [mm]	SpL [mm]	€
2597.030	3	E 6,3	70	35	7,10
2597.033	3,3	E 6,3	70	35	7,10
2597.035	3,5	E 6,3	70	35	7,10
2597.040	4	E 6,3	75	40	7,10
2597.042	4,2	E 6,3	80	45	7,30
2597.045	4,5	E 6,3	80	45	7,30
2597.050	5	E 6,3	86	51	7,30
2597.055	5,5	E 6,3	93	57	7,80
2597.060	6	E 6,3	93	57	7,80
2597.065	6,5	E 6,3	101	63	7,80
2597.068	6,8	E 6,3	101	63	7,80
2597.070	7	E 6,3	109	69	7,80
2597.075	7,5	E 6,3	109	69	9,80
2597.080	8	E 6,3	117	75	9,80
2597.085	8,5	E 6,3	117	75	10,60
2597.090	9	E 6,3	125	81	12,00
2597.100	10	E 6,3	133	87	12,00
2597.110	11	E 6,3	142	94	15,15
2597.120	12	E 6,3	151	101	16,60
2597.130	13	E 6,3	151	101	17,80

Sets

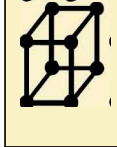
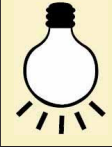
Art.- No.	Description	€
2597.805	Set of 5 pieces in plastic box Ø 3, 4, 5, 6, 8 mm	34,90

	One-piece twist drill bit, fully ground from the solid, long version with hexagonal shank for bit holder (1/4"; E 6,3), polished section of the surface of the cone 118°, blank ground		For drilling alloyed and not alloyed steel and cast steel up to 900 N/mm², grey and malleable iron etc., with a cordless screwdriver. The ground chip flutes guarantee a good chip removal
	HSS-G		It is recommended to use lockable bit holders to avoid the drill bit getting jammed in the drill hole
	Relevant diagrams respectively cordless screwdriver		packing unit = 1, PE tube

1598

 Excellent





Right-Angle-Driver 90fix

FAMAG
...für Besserbohrer®

Art.- No.	Bit [mm]	Angle	Height [mm]	€
1598.750	6,35	90°	40	59,95

Sets

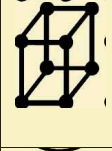

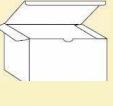
Art.- No.	Description	€
1598.757	90fix set, for woodworking, in wooden case	88,55
1598.758	90fix set, for metalworking, in wooden case	88,55
1598.612	90fix set 13 pcs, for woodworking, in pouch	116,15

	Solid right-angle-driver with aluminium housing and bevel toothed metal gear wheels (ideal transmission of force). Take-up device for all 1/4" bits and drilling tools (e.g. product line 1596) with hexagonal shank. Angle of screwing 90°, exchangeable plastic handle		Professional screwing and drilling "to the last corner" with cordless screwdriver. Maximum transferable torque 50Nm
	aluminium housing		Ideal for screwings with a cordless screwdriver in a small space. Works well in combination with product lines 1596/2596
	Rotation speed of cordless screwdriver max 2000 rpm		Packing unit = 1, SB Blister pack

Technical changes or mistakes reserved! All prices are recommended retail prices additionally value added tax.

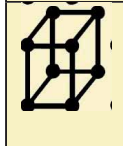
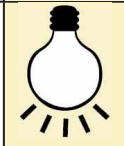
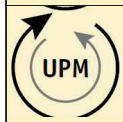
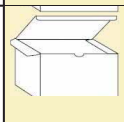

Art.- No.	O-Ø [mm]	OAL [mm]	Effective L. [mm]	PU [pcs]	€
2430.010	1,0	34	12	1	3,95
2430.015	1,5	40	18	1	3,95
2430.020	2,0	49	24	1	3,95
2430.025	2,5	57	30	1	3,80
2430.030	3,0	61	33	1	4,10
2430.031	3,1	65	36	1	4,50
2430.032	3,2	65	36	1	4,50
2430.033	3,3	65	36	1	4,50
2430.035	3,5	70	39	1	4,45
2430.040	4,0	75	43	1	5,05
2430.041	4,1	75	43	1	5,90
2430.042	4,2	75	43	1	5,90
2430.045	4,5	80	47	1	5,90
2430.048	4,8	86	52	1	5,95
2430.050	5,0	86	52	1	6,20
2430.051	5,1	86	52	1	6,35
2430.052	5,2	86	52	1	6,35
2430.055	5,5	93	57	1	7,30
2430.060	6,0	93	57	1	7,75
2430.065	6,5	101	63	1	8,55
2430.068	6,8	109	69	1	8,85
2430.070	7,0	109	69	1	9,60
2430.075	7,5	109	69	1	10,60
2430.080	8,0	117	75	1	11,10
2430.085	8,5	117	75	1	12,85
2430.090	9,0	125	81	1	13,70
2430.095	9,5	125	81	1	15,05
2430.100	10,0	133	87	1	16,05
2430.105	10,5	133	87	1	17,00
2430.110	11,0	142	94	1	18,60
2430.115	11,5	142	94	1	19,35
2430.120	12,0	151	101	1	20,45
2430.125	12,5	151	101	1	22,50
2430.130	13,0	151	101	1	23,15

	Titanium nitrified twist drill, fully ground from the solid, right hand cutting, with spiral type N. Crosswise sharpened acc. to DIN 1412C (from 3,0 mm) 118° for good centering and fast drilling. Tolerance of diameter h8. Professional hard-wearing coating for a long service life		Suitable for highest quality demands of industry and craft. For drilling alloyed and not alloyed steel and cast steel up to 1000 N/mm ² , grey and malleable cast iron, sintered iron, aluminium, copper and bronze
	HSS-G Ti-nitrified		Amazing service life due to highest quality coating - at a real fair price. Also regrinding doesn't affect the service life of the tool, thanks to the high quality material
	Relevant diagrams		packing unit = 1, PE tube







Art.- No.	O-Ø [mm]	OAL [mm]	Effective L. [mm]	PU [pcs]	€
2410.010	1,0	34	12	10	1,25
2410.011	1,1	36	14	10	1,25
2410.012	1,2	38	16	10	1,25
2410.013	1,3	38	16	10	1,25
2410.014	1,4	40	18	10	1,25
2410.015	1,5	40	18	10	1,25
2410.016	1,6	43	20	10	1,25
2410.017	1,7	43	20	10	1,25
2410.018	1,8	46	22	10	1,25
2410.019	1,9	46	22	10	1,25
2410.020	2,0	49	24	10	1,25
2410.021	2,1	49	24	10	1,25
2410.022	2,2	53	27	10	1,25
2410.023	2,3	53	27	10	1,25
2410.024	2,4	57	30	10	1,25
2410.025	2,5	57	30	10	1,25
2410.026	2,6	57	30	10	1,30
2410.027	2,7	61	33	10	1,30
2410.028	2,8	61	33	10	1,30
2410.029	2,9	61	33	10	1,30
2410.030	3,0	61	33	10	1,30
2410.031	3,1	65	36	10	1,30
2410.032	3,2	65	36	10	1,30
2410.033	3,3	65	36	10	1,30
2410.034	3,4	70	39	10	1,30
2410.035	3,5	70	39	10	1,30
2410.036	3,6	70	39	10	1,40
2410.037	3,7	70	39	10	1,45
2410.038	3,8	75	43	10	1,50
2410.039	3,9	75	43	10	1,50
2410.040	4,0	75	43	10	1,50
2410.041	4,1	75	43	10	1,65
2410.042	4,2	75	43	10	1,65
2410.043	4,3	80	47	10	1,65
2410.044	4,4	80	47	10	1,65
2410.045	4,5	80	47	10	1,75
2410.046	4,6	80	47	10	1,75
2410.047	4,7	80	47	10	1,75
2410.048	4,8	86	52	10	1,75
2410.049	4,9	86	52	10	1,80
2410.050	5,0	86	52	10	1,80
2410.051	5,1	86	52	10	1,85
2410.052	5,2	86	52	10	1,85
2410.053	5,3	86	52	10	2,15
2410.054	5,4	93	57	10	2,15
2410.055	5,5	93	57	10	2,15
2410.056	5,6	93	57	10	2,15
2410.057	5,7	93	57	10	2,15
2410.058	5,8	93	57	10	2,25
2410.059	5,9	93	57	10	2,25
2410.060	6,0	93	57	10	2,15
2410.061	6,1	101	63	10	2,40

Art.- No.	O-Ø [mm]	OAL [mm]	Effective L. [mm]	PU [pcs]	€
2410.062	6,2	101	63	10	2,40
2410.063	6,3	101	63	10	2,45
2410.064	6,4	101	63	10	2,45
2410.065	6,5	101	63	10	2,45
2410.066	6,6	101	63	10	2,80
2410.067	6,7	101	63	10	2,80
2410.068	6,8	109	69	10	2,75
2410.069	6,9	109	69	10	3,10
2410.070	7,0	109	69	10	2,90
2410.071	7,1	109	69	10	3,30
2410.072	7,2	109	69	10	3,30
2410.073	7,3	109	69	10	3,30
2410.074	7,4	109	69	10	3,30
2410.075	7,5	109	69	10	3,15
2410.076	7,6	117	75	10	3,65
2410.077	7,7	117	75	10	3,65
2410.078	7,8	117	75	10	3,65
2410.079	7,9	117	75	10	3,65
2410.080	8,0	117	75	10	3,65
2410.081	8,1	117	75	10	3,90
2410.082	8,2	117	75	10	3,90
2410.083	8,3	117	75	10	4,25
2410.084	8,4	117	75	10	4,25
2410.085	8,5	117	75	5	4,10
2410.086	8,6	125	81	5	4,65
2410.087	8,7	125	81	5	4,65
2410.088	8,8	125	81	5	4,65
2410.089	8,9	125	81	5	4,65
2410.090	9,0	125	81	5	4,45
2410.091	9,1	125	81	5	4,95
2410.092	9,2	125	81	5	4,95
2410.093	9,3	125	81	5	4,95
2410.094	9,4	125	81	5	4,95
2410.095	9,5	125	81	5	5,10
2410.096	9,6	133	87	5	5,70
2410.097	9,7	133	87	5	5,70
2410.098	9,8	133	87	5	5,70
2410.099	9,9	133	87	5	5,70
2410.100	10,0	133	87	5	5,50
2410.102	10,2	133	87	5	6,95
2410.105	10,5	133	87	5	6,95
2410.110	11,0	142	94	5	7,75
2410.115	11,5	142	94	5	8,55
2410.120	12,0	151	101	5	9,50
2410.125	12,5	151	101	5	10,65
2410.130	13,0	151	101	5	11,75

Sets

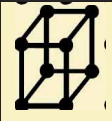
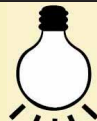

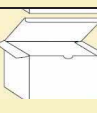

Art.- No.	Description	€
2410.805	Set of 5 pcs. Ø 3, 4, 5, 6, 8 mm, in PVC box	11,60
2410.519	Set of 19 pcs. Ø 1 - 10 mm, 0,5 mm rising, in Rose box	54,40
2410.525	Set of 25 pcs. Ø 1 - 13 mm, 0,5 mm rising, in rose box	81,40

	Twist drill HSS-G acc. to DIN 338, fully ground from the solid, right hand cutting, spiral type N, tolerance of diameter h 8. Polished section of the surface of the cone 118°, blank ground		Suitable for highest quality demands of industry and craft. For drilling alloyed and not alloyed steel and cast steel up to 900 N/mm ² , grey and malleable cast iron, spheroidale graphite iron, sintered iron, German silver, graphite etc.
	HSS-G		Professional quality for high quality demands. For even higher quality demands, e.g. high-grade steel V2A, we recommend our product line 2420 made of cobalt alloyed HSS, with a special spiral and crosswise grinding
	Relevant diagrams		packing unit = 10, in PE box., from Ø 8,5 mm packing unit = 5, in PE box (price unit = per piece in a packing unit)





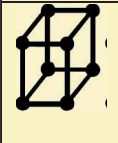

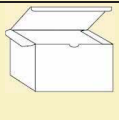
Art.- No.	Description	O-Ø [mm]	OAL [mm]	Effective L. [mm]	PU [pcs]	€
2420.015	End of Series	1,5	40	18	10	2,20
2420.016	End of Series	1,6	43	20	10	2,25
2420.017	End of Series	1,7	43	20	10	2,25
2420.018	End of Series	1,8	46	22	10	2,25
2420.020	End of Series	2,0	49	24	10	2,30
2420.021	End of Series	2,1	49	24	10	2,30
2420.022	End of Series	2,2	53	27	10	2,30
2420.023	End of Series	2,3	53	27	10	2,30
2420.024	End of Series	2,4	57	30	10	2,30
2420.025	End of Series	2,5	57	30	10	2,30
2420.026	End of Series	2,6	57	30	10	2,45
2420.027	End of Series	2,7	61	33	10	2,45
2420.028	End of Series	2,8	61	33	10	2,45
2420.030		3,0	61	33	10	2,45
2420.031	End of Series	3,1	65	36	10	2,75
2420.032	End of Series	3,2	65	36	10	2,75
2420.033	End of Series	3,3	65	36	10	2,75
2420.034	End of Series	3,4	70	39	10	2,75
2420.035		3,5	70	39	10	2,90
2420.036	End of Series	3,6	70	39	10	2,90
2420.037	End of Series	3,7	70	39	10	2,90
2420.038	End of Series	3,8	75	43	10	2,90
2420.039	End of Series	3,9	75	43	10	2,90
2420.040		4,0	75	43	10	3,25
2420.041	End of Series	4,1	75	43	10	3,25
2420.042	End of Series	4,2	75	43	10	3,25
2420.043	End of Series	4,3	80	47	10	3,25
2420.044	End of Series	4,4	80	47	10	3,25
2420.045		4,5	80	47	10	3,65
2420.046	End of Series	4,6	80	47	10	3,75
2420.047	End of Series	4,7	80	47	10	3,75
2420.049	End of Series	4,9	86	52	10	3,75
2420.050		5,0	86	52	10	3,95
2420.051	End of Series	5,1	86	52	10	4,20
2420.052	End of Series	5,2	86	52	10	4,20
2420.053	End of Series	5,3	86	52	10	4,20
2420.054	End of Series	5,4	93	57	10	4,20
2420.055	End of Series	5,5	93	57	10	4,25
2420.056	End of Series	5,6	93	57	10	4,75
2420.057	End of Series	5,7	93	57	10	4,75
2420.058	End of Series	5,8	93	57	10	4,75
2420.059	End of Series	5,9	93	57	10	4,75
2420.060	End of Series	6,0	93	57	10	4,95
2420.061	End of Series	6,1	101	63	10	5,25
2420.062	End of Series	6,2	101	63	10	5,25
2420.063	End of Series	6,3	101	63	10	5,25
2420.064	End of Series	6,4	101	63	10	5,25
2420.065	End of Series	6,5	101	63	10	5,25
2420.066	End of Series	6,6	101	63	10	6,20
2420.067	End of Series	6,7	101	63	10	6,20
2420.069	End of Series	6,9	109	69	10	6,20
2420.070	End of Series	7,0	109	69	10	6,20
2420.071	End of Series	7,1	109	69	10	6,55

Art.- No.	Description	O-Ø [mm]	OAL [mm]	Effective L. [mm]	PU [pcs]	€
2420.072	End of Series	7,2	109	69	10	6,55
2420.074	End of Series	7,4	109	69	10	6,55
2420.075	End of Series	7,5	109	69	10	6,55
2420.076	End of Series	7,6	117	75	10	7,40
2420.077	End of Series	7,7	117	75	10	7,40
2420.078	End of Series	7,8	117	75	10	7,40
2420.079	End of Series	7,9	117	75	10	7,40
2420.080	End of Series	8,0	117	75	10	7,60
2420.081	End of Series	8,1	117	75	10	8,45
2420.082	End of Series	8,2	117	75	10	8,45
2420.083	End of Series	8,3	117	75	10	8,45
2420.084	End of Series	8,4	117	75	10	8,45
2420.085	End of Series	8,5	117	75	5	8,45
2420.086	End of Series	8,6	125	81	5	9,10
2420.087	End of Series	8,7	125	81	5	9,10
2420.088	End of Series	8,8	125	81	5	9,10
2420.089	End of Series	8,9	125	81	5	9,10
2420.090	End of Series	9,0	125	81	5	9,10
2420.091	End of Series	9,1	125	81	5	10,25
2420.092	End of Series	9,2	125	81	5	10,25
2420.093	End of Series	9,3	125	81	5	10,25
2420.094	End of Series	9,4	125	81	5	10,25
2420.095	End of Series	9,5	125	81	5	10,25
2420.096	End of Series	9,6	133	87	5	11,25
2420.097	End of Series	9,7	133	87	5	11,25
2420.098	End of Series	9,8	133	87	5	11,25
2420.099	End of Series	9,9	133	87	5	11,25
2420.100	End of Series	10,0	133	87	5	11,25
2420.102	End of Series	10,2	133	87	5	17,65
2420.105	End of Series	10,5	133	87	5	17,65
2420.110	End of Series	11,0	142	94	5	17,65
2420.115	End of Series	11,5	142	94	5	20,85
2420.120	End of Series	12,0	151	101	5	20,85
2420.125	End of Series	12,5	151	101	5	24,55
2420.130	End of Series	13,0	151	101	5	24,55

	<p>Twist drill, made of cobalt alloyed HSS, acc. to DIN 338, fully ground from the solid. Fitted with a special spiral for good chip removal and greasing materials. Crosswise sharpened acc. to DIN 1412C, point angle 135°, tolerance of diameter h8</p>		<p>For extraordinary demands of industry, craft and household. Very well suitable for drilling stainless steel V2A, V4A and steel with higher content of alloy and/or higher stability over 1300 N/mm². Furthermore applicable for heat resistant, non-corroding and acid resistant steel, special alloy, malleable and cast iron, bronze, weld seams, chromium-nickel steel, aluminium, brass and all sorts of plastics</p>
	<p>HSS-G Co</p>		<p>Optimally suitable for strongest demands. We also offer a long version product line 2450 (acc. to DIN 340). For sheet metal working we recommend product line 2440 with spiral type N</p>
	<p>Relevant diagrams</p>		<p>packing unit = 10, PE box., from Ø 8,5 mm packing unit = 5, PE box (price unit = per piece in a packing unit)</p>



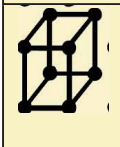
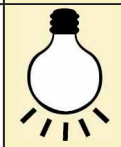

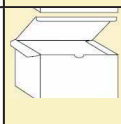

Art.- No.	Description	O-Ø [mm]	OAL [mm]	Effective L. [mm]	PU [pcs]	€
2450.020		2,0	85	56	10	3,50
2450.025		2,5	95	62	10	3,85
2450.030		3,0	100	66	10	4,05
2450.031	End of Series	3,1	106	69	10	4,65
2450.032	End of Series	3,2	106	69	10	4,65
2450.033	End of Series	3,3	112	73	10	4,65
2450.035		3,5	112	73	10	4,65
2450.040		4,0	119	78	10	5,05
2450.041	End of Series	4,1	119	78	10	6,45
2450.042	End of Series	4,2	119	78	10	6,45
2450.045	End of Series	4,5	126	82	10	6,45
2450.048	End of Series	4,8	132	87	10	7,55
2450.050		5,0	132	87	10	7,55
2450.051	End of Series	5,1	132	87	10	7,55
2450.052	End of Series	5,2	132	87	10	8,70
2450.053	End of Series	5,3	132	87	10	8,70
2450.055	End of Series	5,5	139	91	10	8,70
2450.057	End of Series	5,7	139	91	10	9,80
2450.058	End of Series	5,8	139	91	10	9,80
2450.060		6,0	139	91	10	9,80
2450.065		6,5	148	97	10	12,05
2450.068	End of Series	6,8	156	102	10	13,95
2450.070	End of Series	7,0	156	102	10	13,95
2450.075	End of Series	7,5	156	102	10	15,35
2450.080		8,0	165	109	10	15,35
2450.085	End of Series	8,5	165	109	5	18,15
2450.090	End of Series	9,0	175	115	5	18,90
2450.095	End of Series	9,5	175	115	5	20,10
2450.100		10,0	184	121	5	22,80
2450.102	End of Series	10,2	184	121	5	30,70
2450.105		10,5	184	121	5	30,70
2450.110	End of Series	11,0	195	128	5	30,70
2450.115	End of Series	11,5	195	128	5	35,95
2450.120	End of Series	12,0	205	134	5	35,95
2450.125	End of Series	12,5	205	134	5	44,10
2450.130	End of Series	13,0	205	134	5	44,10

	Twist drill made of cobalt alloyed HSS-G, acc. to DIN 340, fully ground from the solid, long version, special spiral form, for a good chip removal when drilling deep holes and for greasing materials. Crosswise sharpened acc to. DIN 1412C, point angle 135°, tolerance of diameter h8		For extraordinary demands of industry, craft and household. Very good for drilling stainless steel V2A; V4A and steel with higher content of alloy. Furthermore suitable for heat resistant, non-corroding and acid resisting steel, special alloy, malleable and cast iron, bronze, weld seams, chromium-nickel steel, aluminium, brass etc.
	HSS-G Co alloyed		Specially suitable for hardest demands, in a practical long version
	Relevant diagrams		packing unit = 1, PE box., from Ø 8,5 mm packing unit = 5, PE box (price unit = per piece in a packing unit)

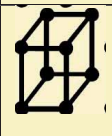

Art.- No.	O-Ø [mm]	OAL [mm]	Effective L. [mm]	PU [pcs]	€
2461.020	2,0	125	85	1	11,95
2461.025	2,5	140	95	1	11,95
2461.030	3,0	150	100	1	14,65
2461.035	3,5	165	115	1	16,20
2461.040	4,0	175	120	1	16,50
2461.045	4,5	185	125	1	19,15
2461.050	5,0	195	135	1	21,60
2461.055	5,5	205	140	1	22,55
2461.060	6,0	205	140	1	25,80
2461.065	6,5	215	150	1	30,55
2461.070	7,0	225	155	1	31,85
2461.075	7,5	225	155	1	34,90
2461.080	8,0	240	165	1	38,60
2461.085	8,5	240	165	1	43,55
2461.090	9,0	250	175	1	46,75
2461.095	9,5	250	175	1	49,45
2461.100	10,0	265	185	1	53,60
2461.105	10,5	265	185	1	54,85
2461.110	11,0	280	195	1	59,80
2461.115	11,5	280	195	1	67,00
2461.120	12,0	295	205	1	73,40
2461.125	12,5	295	205	1	77,50
2461.130	13,0	295	205	1	81,20

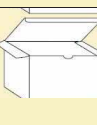
	Special twist drill made of cobalt alloyed HSS, acc. to DIN 1869, fully ground of the solid, extra long version, right hand cutting. Profile crosswise sharpened 135°		Solid special drill for drilling extremely deep holes under difficult conditions, e.g. poorly chip removal. Suitable for drilling cast iron and steel up to 1300 N/mm²
	HSS-G Co		Specially suitable for hardest quality demands. For an even longer version take a look at our product line 2599
	Relevant diagrams		packing unit = 1, PE tube



OAL 150 mm

Art.- No.	O-Ø [mm]	SØ [mm]	OAL [mm]	Effective L. [mm]	PU [pcs]	€
2599.103	3	3	150	100	1	11,25
2599.104	4	4	150	100	1	12,40
2599.105	5	5	150	100	1	13,10
2599.106	6	6	150	100	1	13,90
2599.107	7	7	150	100	1	18,05
2599.108	8	8	150	100	1	18,05
2599.109	9	9	150	100	1	19,15
2599.110	10	10	150	100	1	20,95
2599.111	11	11	150	100	1	23,70

OAL 250 mm

Art.- No.	O-Ø [mm]	SØ [mm]	OAL [mm]	Effective L. [mm]	PU [pcs]	€
2599.203	3	3	250	200	1	15,15
2599.204	4	4	250	200	1	17,85
2599.205	5	5	250	200	1	20,35
2599.206	6	6	250	200	1	22,80
2599.207	7	7	250	200	1	29,40
2599.208	8	8	250	200	1	29,40
2599.209	9	9	250	200	1	32,80
2599.210	10	10	250	200	1	35,70
2599.211	11	11	250	200	1	41,15
2599.212	12	12	250	200	1	45,30
2599.213	13	13	250	200	1	48,10
2599.214	14	13	250	200	1	52,05
2599.215	15	13	250	200	1	59,75
2599.216	16	13	250	200	1	65,85
2599.218	18	13	250	200	1	97,30
2599.220	20	13	250	200	1	123,55
2599.222	22	13	250	200	1	150,30
2599.224	24	13	250	200	1	179,85
2599.225	25	13	250	200	1	196,85

OAL 315 mm

Art.- No.	O-Ø [mm]	SØ [mm]	OAL [mm]	Effective L. [mm]	PU [pcs]	€
2599.303	3	3	315	250	1	19,70
2599.304	4	4	315	250	1	23,25
2599.305	5	5	315	250	1	26,50
2599.306	6	6	315	250	1	29,65
2599.307	7	7	315	250	1	38,25
2599.308	8	8	315	250	1	38,25
2599.309	9	9	315	250	1	42,60
2599.310	10	10	315	250	1	46,45
2599.311	11	11	315	250	1	53,40
2599.312	12	12	315	250	1	58,95
2599.313	13	13	315	250	1	62,50
2599.314	14	13	315	250	1	68,80
2599.315	15	13	315	250	1	80,05
2599.316	16	13	315	250	1	93,25







OAL 400 mm

Art.- No.	Description	O-Ø [mm]	SØ [mm]	OAL [mm]	Effective L. [mm]	PU [pcs]	€
2599.403	End Of Series	3	3	400	300	1	25,60
2599.404	End Of Series	4	4	400	300	1	30,25
2599.405	End Of Series	5	5	400	300	1	34,40
2599.406	End Of Series	6	6	400	300	1	38,55
2599.407	End Of Series	7	7	400	300	1	49,65
2599.408	End Of Series	8	8	400	300	1	49,65
2599.409	End Of Series	9	9	400	300	1	55,40
2599.410	End Of Series	10	10	400	300	1	60,30
2599.411	End Of Series	11	11	400	300	1	69,35
2599.412	End Of Series	12	12	400	300	1	76,60
2599.413	End Of Series	13	13	400	300	1	81,25
2599.414	End Of Series	14	13	400	300	1	89,40
2599.415	End Of Series	15	13	400	300	1	104,05
2599.416	End Of Series	16	13	400	300	1	121,15

OAL 460 mm

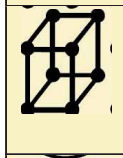
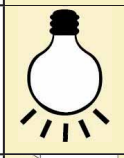
Art.- No.	O-Ø [mm]	SØ [mm]	OAL [mm]	Effective L. [mm]	PU [pcs]	€
2599.603	3	3	460	380	1	49,90
2599.604	4	4	460	380	1	49,90
2599.605	5	5	460	380	1	49,90
2599.606	6	6	460	380	1	58,60
2599.607	7	7	460	380	1	67,85
2599.608	8	8	460	380	1	67,85
2599.609	9	9	460	380	1	78,70
2599.610	10	10	460	380	1	78,70
2599.611	11	11	460	380	1	84,80
2599.612	12	12	460	380	1	77,65
2599.613	13	13	460	380	1	103,55
2599.614	14	14	460	380	1	117,95
2599.615	15	15	460	380	1	132,95
2599.616	16	16	460	380	1	151,95

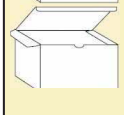
	<p>Twist drill made of HSS, fully ground from the solid, long version, cylindrical, special spiral for good chip removal when drilling deep holes and for greasing materials. Profile crosswise sharpened acc. to DIN 1412C, point angle 135°. Tolerance of diameter h8</p>		<p>Suitable for highest quality demands of industry and craft. For drilling alloyed and not alloyed steel and cast steel up to 900 N/mm², grey and malleable cast iron, spheroidale graphite iron, sintered iron, German silver, graphite and so on</p>
	<p>HSS-G</p>		<p>Specially suitable for highest quality demands, here available in four lengths at a very fair price</p>
	<p>Relevant diagrams</p>		<p>packing unit = 1, SB in Rose tube</p>

2440

Profi

Twist Drill, Double Sided, HSS-G

FAMAG
...für Besserbohrer®



Art.- No.	O-Ø [mm]	OAL [mm]	Effective L. [mm]	PU [pcs]	€
2440.025	2,5	43	10	1	2,90
2440.030	3,0	46	12	1	3,05
2440.031	3,1	49	12	1	3,30
2440.032	3,2	49	12	1	3,25
2440.033	3,3	49	12	1	3,40
2440.035	3,5	52	12	1	3,40
2440.040	4,0	55	12	1	3,75
2440.041	4,1	55	12	1	3,55
2440.042	4,2	55	12	1	3,75
2440.045	4,5	58	12	1	3,60
2440.048	4,8	62	14	1	3,80
2440.050	5,0	62	14	1	4,15
2440.051	5,1	62	14	1	4,15
2440.052	5,2	66	14	1	4,25
2440.055	5,5	66	16	1	3,95
2440.060	6,0	66	19	1	4,35

	Special twist drill HSS-G, according to works standard specification, fully ground from the solid, extra short version, right hand cutting, spiral type N, crosswise sharpened, 118°. Tolerance of diameter h8, blank ground		Double ended twist drill for drilling thin sheet. Solid construction for power drill. For drilling thin work pieces like sheets of steel, brass, zinc, copper, aluminium as well as plastic plates
	HSS-G		Specially suitable for roofers and their sheet metal forming
	approx. 2500 rpm, power drill		packing unit = 1, PE tube

3535

Hobby

Drill and Milling Cutter, HSS

FAMAG
...für Besserbohrer®



Art.- No.	O-Ø [mm]	SØ [mm]	OAL [mm]	€
3535.006	6	6	90	13,95
3535.008	8	8	90	20,35

	Milling cutter with twist drill head (ground point angle 118°) and chip flutes with roughing teeth		For drilling and milling outlines with one tool. Suitable for wood, plasterboard, plastics and - limited - nonferrous metals
	HSS		Especially recommendable for use with hand drill, not suitable for use with steel
	approx. 2500 rpm, basis wood		packing unit = 1, PE tube

3540







Classic

Countersink, HSS

FAMAG[®]
... für Besserbohrer[®]

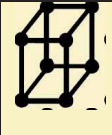
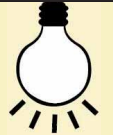
Art.- No.	0-Ø [mm]	SØ [mm]	OAL [mm]	€
3540.012	12	8	46	13,90
3540.016	16	8	47	17,45
3540.020	20	8	47	25,80

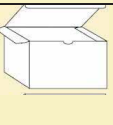
	Countersink three edged, countersinking angle 90°		Countersinking and deburring in all metals, due to the high surface performance without any "chattering"
	HSS		Easy regrinding
	approx. 500 rpm, basis St 37		packing unit = 1, PE tube

3541







Classic

Special Countersink with Lateral Hole, HSS

FAMAG[®]
... für Besserbohrer[®]

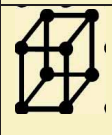
Art.- No.	0-Ø [mm]	SØ [mm]	OAL [mm]	€
3541.001	2-5	6	45	16,60
3541.002	5-10	8	48	19,30
3541.003	10-15	10	65	33,85
3541.004	15-20	12	85	59,25

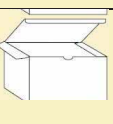
	Countersink with bored (lateral) hole with one edge and countersinking angle of 90°		Countersinking in all metals, specially good results with nonferrous metals and hard wood
	HSS		Easy handling thanks to the large contact surface, no "chattering"
	approx. 500 rpm		packing unit = 1, PE tube

Technical changes or mistakes reserved! All prices are recommended retail prices additionally value added tax.

3690





 Classic

Hole Enlarger, HSS



Art.- No.	O-Ø [mm]	SØ [mm]	OAL [mm]	€
3690.001	3 - 14	6	62	25,80
3690.002	6 - 20	8	70	29,40
3690.003	16 - 30	10	75	53,30

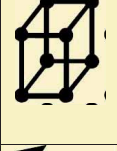
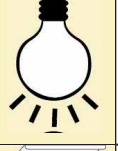

	Two edged hole cutter for metal sheet		Stageless drilling of large holes and drilling out of existing holes of thin-walled materials
	HSS		Suitable for sheet steel 0,1 - 2 mm, V2A sheet 0,1 - 1 mm, non-ferrous metals 0,1 - 5 mm and plastics up to 10 mm
	approx. 1000 rpm, basis non-ferrous metal		packing unit = 1, PE tube

3692





 Classic

Step Drill, HSS



Art.- No.	O-Ø [mm]	SØ [mm]	OAL [mm]	€
3692.012	4 - 12	6	69	45,05
3692.020	4 - 20	8	73	58,60
3692.030	6 - 30	10	95	85,90

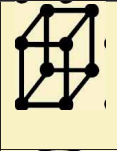
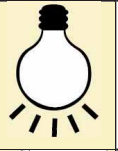

	Two edged hole cutter for metal sheet, cylindrical gradation, chip groove with scale of diameter		For working without pre-drilling and burring by the next grade at the same time
	HSS		Also suitable for thinnest sheet metals. No pre-drilling necessary, burr-free working without "chattering"
	approx. 1000 rpm, basis non-ferrous metal		packing unit = 1, PE tube

Hand Tools

121

Piercer	122
Dowel sharpener	123
Countersink with Handle	123
Dowel Marker	124
Gimlet	124



2000/...

 Profi

Piercer

FAMAG
...für Besserbohrer

Piercer with continous blade





Art.- No.	Ø [mm]	OAL [mm]	Effective L. [mm]	€
2000.100	6	180	100	9,30

Piercer with round blade

Art.- No.	Ø [mm]	OAL [mm]	Effective L. [mm]	€
2001.100	6	180	100	10,45

Piercer with sharpened chamfer

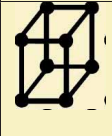
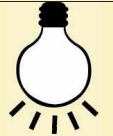
Art.- No.	Ø [mm]	OAL [mm]	Effective L. [mm]	€
2006.100	6	150	70	10,85

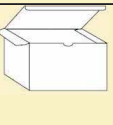
 <p>Piercer with continous blade, lacquered wooden handle and striking cap: Piercer with round blade Piercer with a blade of 6 mm, square edged Piercer with sharpened chamfer</p>	 <p>For piercing into all European solid wood, all laminated and uncoated boards</p>
 <p>tool steel</p>	 <p>The chamfer of the piercer allows an especially easy pre-piercing and convenient handling</p>
 <p>UPM</p>	 <p>packing unit = 1, in quadropack</p>

1895







 Profi

Set of Cutting Tools for Wooden Threads

FAMAG
...für Besserbohrer

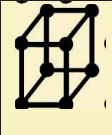
Art.- No.	Ø [mm]	Ø [Inch]	Core [mm]	lead/1" [mm]	€
1895.013	13	1/2	11	8	331,50
1895.016	16	5/8	14	7	334,40
1895.019	19	3/4	16	6	348,25
1895.022	22	7/8	18	5,5	388,15
1895.025	25	1	21	5	489,65
1895.028	28	1 1/8	23	4,5	561,30
1895.032	32	1 1/4	26	4	638,90

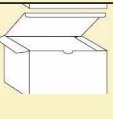

 <p>Set of two pcs with die stock and screw tap</p>	 <p>For cutting internal and external threads in wooden workpieces like chair legs, nutcrackers etc.</p>
 <p>Tool steel</p>	 <p>Suitable for all kinds of solid wood</p>
 <p>By hand</p>	 <p>packing unit = 1, cardboard</p>

Technical changes or mistakes reserved! All prices are recommended retail prices additionally value added tax.

2009







Classic

Dowel sharpener

FAMAG[®]
...für Besserbohrer[®]

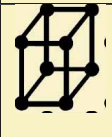
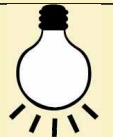
Art.- No.	Ø [mm]	OAL [mm]	SØ [mm]	€
2009.020	4-20	80	8	50,80
2009.030	6-30	100	10	77,95

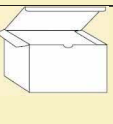
	Dowel sharpener with one edge and parallel shank. Inner angle approx. 55°		For sharpening of all dowels so that they can easily be put into the drill holes
	Tool steel		Dowels must not be lead by hand to the drilling machine
	500 - 1000 rpm, basis beech wood		packing unit = 1, SB packaging in PE tube

3533



Profi

Countersink with Handle

FAMAG[®]
...für Besserbohrer[®]







Countersink with plastic handle

Art.- No.	Ø [mm]	€
3533.012	12	6,25
3533.016	16	6,50

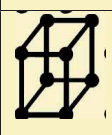
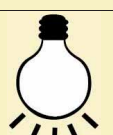

Countersink with wooden handle

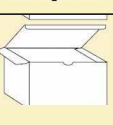
Art.- No.	Ø [mm]	€
3533.112	12	6,45
3533.116	16	6,80

	Countersink with five edged 90° countersink, with either wooden or plastic handle		For fast countersinking by hand in all solid woods and board materials
	Tool steel		The wooden grip lies particularly comfortable in your hand
	By hand		packing unit = 1, SB on punch card

Technical changes or mistakes reserved! All prices are recommended retail prices additionally value added tax.

3685









Classic

Dowel Marker

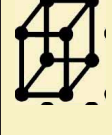
FAMAG[®]
...für Besserbohrer[®]

Art.- No.	Description	Ø [mm]	€
3685.006	PU = 1 (contains 10 pcs.)	6	6,20
3685.008	PU = 1 (contains 10 pcs.)	8	6,30
3685.010	PU = 1 (contains 10 pcs.)	10	7,15

	Conventional dowel marker with centre point, accurately fitting		For exact marking of blind dowel holes in all kinds of wood and uncoated boards
	Steel		The good dimensioned tip guarantees a perfect working
			packing unit = 1 (10 pcs. in PE tube)

2152



Classic







Gimlet

FAMAG[®]
...für Besserbohrer[®]

Art.- No.	Description	Ø-Ø [mm]	OAL [mm]	€
2152.002	PU = 1 (contains 10 pcs.)	2	115	33,00
2152.003	PU = 1 (contains 10 pcs.)	3	125	33,00
2152.004	PU = 1 (contains 10 pcs.)	4	140	37,00
2152.005	PU = 1 (contains 10 pcs.)	5	145	41,50
2152.006	PU = 1 (contains 10 pcs.)	6	155	63,00

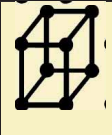
Sets

Art.- No.	Description	€
2152.503	3 pcs. Set on Rose plastic clip Ø 3, 4, 5 mm	9,85
2152.505	5 pcs. Set on Rose plastic clip Ø 2, 3, 4, 5, 6 mm	17,35

	Classical gimlet in solid version, black, with lug		For manual pre-drilling of holes by hand in all sorts of wood
	Tool steel		We recommend piercing with a pricker 2006.100 for hard wood
	show what you can!		Packing unit = 10 pcs. SB packaging, sets in Rose quattro packaging

Technical changes or mistakes reserved! All prices are recommended retail prices additionally value added tax.



Information 125

Quality products presented in an optimal way	126
Speed diagram	138
Quality classification	139
Article index	140
General terms and conditions	142
Custom-made tools	144
Service and contact	145

1410 Auger Bit Lewis tool steel

Three Basis holder (Deep, Medium, Standard)

Standard	1.	2.	3.	4.	5.	6.	7.	8.	€
1410.4									
Ø in mm	10	12	14	16	18	20	22	24	
Qty.	2 pcs.	2 pcs.	2 pcs.	2 pcs.	2 pcs.	2 pcs.	2 pcs.	2 pcs.	
€	42,30	43,40	51,20	57,60	61,20	66,90	83,50	90,80	496,90 €
Medium	1.	2.	3.	4.	5.	6.	7.	8.	€
1410.3									
Ø in mm	6	8	10	12	14	16	18	20	
Qty.	2 pcs.	2 pcs.	2 pcs.	2 pcs.	2 pcs.	2 pcs.	2 pcs.	2 pcs.	
€	32,00	32,00	32,00	35,10	37,70	42,90	45,20	52,50	309,40 €
Deep	1.	2.	3.	4.	5.	6.	7.	8.	€
1410.2									
Ø in mm	6	8	10	12	14	16	18	20	
Qty.	2 pcs.	2 pcs.	2 pcs.	2 pcs.	2 pcs.	2 pcs.	2 pcs.	2 pcs.	
€	24,80	24,80	24,80	25,90	28,30	30,20	33,20	36,70	228,70 €
Total								1.035,00 €	



1410 Auger Bit Lewis tool steel

Six Basis holder (2 x Deep, Medium, Standard)

Standard	1.	2.	3.	4.	5.	6.	7.	8.	1.	2.	3.	4.	5.	6.
1410.4														
Ø	6	8	10	12	14	16	18	20	22	24	26	28	30	32
i mm	2 pcs.	2 pcs.	2 pcs.	2 pcs.	2 pcs.	2 pcs.	2 pcs.	2 pcs.	2 pcs.	2 pcs.	2 pcs.	2 pcs.	2 pcs.	2 pcs.
Q	42t30	42t30	42t30	43t40	51t20	57t60	61t20	66ty0	83t50	y0t80	102ty0	114t20	116ty0	151t50
Medium	1.	2.	3.	4.	5.	6.	7.	8.	1.	2.	3.	4.	5.	6.
1410.3														
Ø	6	8	10	12	14	16	18	20	22	24	26	28	30	32
i mm	2 pcs.	2 pcs.	2 pcs.	2 pcs.	2 pcs.	2 pcs.	2 pcs.	2 pcs.	2 pcs.	2 pcs.	2 pcs.	2 pcs.	2 pcs.	2 pcs.
Q	32t00	32t00	32t00	35t10	37t70	42ty0	45t20	52t50	63t00	64t70	72ty0	81t10	87t40	120t70
Deep	1.	2.	3.	4.	5.	6.	7.	8.	1.	2.	3.	4.	5.	6.
1410.2														
Ø	6	8	10	12	14	16	18	20	22	24	26	28	30	32
i mm	2 pcs.	2 pcs.	2 pcs.	2 pcs.	2 pcs.	2 pcs.	2 pcs.	2 pcs.	2 pcs.	2 pcs.	2 pcs.	2 pcs.	2 pcs.	2 pcs.
Q	24t80	24t80	24t80	25ty0	28t30	30t20	33t20	36t70	43t70	47t30	54t50	60ty0	66ty0	86t40

Total 2.454,60 €



1594 Brad Point Drill bit MIX

One Smartdisplay (3 x 8)

Standard	1.	2.	3.	4.	5.	6.	7.	8.	
3500.									
9 Ø i i	3	4	5	6	8	10	12	13	
n r r	2 pcs.	2 pcs.	2 pcs.	2 pcs.	2 pcs.	2 pcs.	2 pcs.	2 pcs.	
,	5t00	5t60	6t10	6t30	7t30	8t70	11t70	13t80	64t50 ,
Medium	1.	2.	3.	4.	5.	6.	7.	8.	
1593.									
9 Ø i i	3	4	5	6	7	8	10	12	
n r r	2 pcs.	2 pcs.	2 pcs.	2 pcs.	2 pcs.	2 pcs.	2 pcs.	2 pcs.	
,	36t00	36t00	37t40	40t20	44t00	44t00	55t40	62t30	355t30 ,
Deep	1.	2.	3.	4.	5.	6.	7.	8.	
1594.									
9 Ø i i	3	4	5	6	8	10	12	13	
n r r	2 pcs.	2 pcs.	2 pcs.	2 pcs.	2 pcs.	2 pcs.	2 pcs.	2 pcs.	
,	11t50	12t40	13t10	13t70	18t50	25t60	3yt60	42t60	177t00 ,
Total								596,80 €	

128



1594 Brad Point Drill bit - Vario Mix

One Smartdisplay (3 x 8)

Standard	1.	2.	3.	4.	5.	6.	7.	8.	€
1594.									
Ø in mm	2	2,5	3	3,5	4	4,5	5	5,5	
Qty.	2 pcs.	2 pcs.	2 pcs.	2 pcs.	2 pcs.	2 pcs.	2 pcs.	2 pcs.	
€	14,40	14,40	11,50	12,40	12,40	13,10	13,10	13,70	105,00 €
Medium	1.	2.	3.	4.	5.	6.	7.	8.	€
1594.									
Ø in mm	6	6,5	7	8	9	10	11	12	
Qty.	2 pcs.	2 pcs.	2 pcs.	2 pcs.	2 pcs.	2 pcs.	2 pcs.	2 pcs.	
€	13,70	16,10	16,80	18,50	22,50	25,60	33,20	39,60	186,00 €
Deep	1.	2.	3.	4.	5.	6.	7.	8.	€
1594.									
Ø in mm	12,5	13	14	15	16	18	20	Vario	
Qty.	2 pcs.	2 pcs.	2 pcs.	2 pcs.	2 pcs.	2 pcs.	2 pcs.	2 pcs.	
€	48,10	42,60	64,00	75,40	84,60	106,10	133,40	71,30	625,50 €
Total									916,50 €



3500 Brad Point Drill Bit - Countersink Mix

One Smartdisplay (3 x 6)

Standard	1.	2.	3.	4.	5.	6.	s
3500.							
, Ømm	3	4	5	6	7	18	
i mm	20 pc.	20 pc.	20 pc.	20 pc.	20 pc.	20 pc.	
s	508	508	608	608	708	708	ØyØ80
Medium	1.	2.	3.	4.	5.	6.	s
2100.							
, Ømm	3	4	5	6	7	18	
i mm	20 pc.	20 pc.	20 pc.	20 pc.	20 pc.	20 pc.	
s	2608	2608	2608	2608	3208	3208	Ø6yØ80
Deep	1.	2.	3.	4.	5.	6.	s
1775.							
, Ømm	18	13	16	28	25	38	
i mm	20 pc.	20 pc.	20 pc.	20 pc.	20 pc.	20 pc.	
s	3108	3308	3408	3708	4108	5508	Ø48Ø80
Total						449,20 €	

130



1622 Bormax 2.0

One Display (Deep, Medium, Standard)

Standard	1.	2.	3.	4.	5.	6.	7.	€
1622.								
Ø in mm	15	16	17	18	19	20	22	
Qty.	2 pcs.	2 pcs.	2 pcs.	2 pcs.	2 pcs.	2 pcs.	2 pcs.	
€	44,00	44,00	47,90	47,90	57,50	47,90	51,80	341,00 €
Medium	1.	2.	3.	4.	5.	6.	7.	€
1622.								
Ø in mm	23	24	25	26	28	30	32	
Qty.	2 pcs.	2 pcs.	2 pcs.	2 pcs.	2 pcs.	2 pcs.	2 pcs.	
€	53,40	53,40	55,30	55,30	64,00	64,00	64,00	409,40 €
Deep	1.	2.	3.	4.	5.	6.	7.	€
1622.								
Ø in mm	34	35	40	45	50	55	60	
Qty.	2 pcs.	2 pcs.	2 pcs.	2 pcs.	2 pcs.	2 pcs.	2 pcs.	
€	77,60	77,60	90,20	118,10	131,00	192,00	198,30	884,80 €
Total							1.635,20 €	



1663 + 1624 Bormax MIX

One Display (3x7)

Standard	1.	2.	3.	4.	5.	6.	7.	€
1663.								
∅ in mm	15	20	25	30	35	40	50	
Qty.	2 pcs.	2 pcs.	2 pcs.	2 pcs.	2 pcs.	2 pcs.	2 pcs.	
€	119,00	122,20	125,50	128,80	134,80	160,00	236,60	1.026,90 €
Medium	1.	2.	3.	4.	5.	6.	7.	€
1624.								
∅ in mm	15	16	16,2	18	20	22	25	
Qty.	2 pcs.	2 pcs.	2 pcs.	2 pcs.	2 pcs.	2 pcs.	2 pcs.	
€	61,90	61,90	66,00	66,00	66,00	70,20	73,50	465,50 €
Deep	1.	2.	3.	4.	5.	6.	7.	€
1624.								
∅ in mm	30	35	40	45	50	Pre Drill	Brad point.	
Qty.	2 pcs.	2 pcs.	2 pcs.	2 pcs.	2 pcs.	4 pcs.	4 pcs.	
€	82,10	95,80	108,50	138,30	149,20	53,60	44,00	671,50 €
Total								2.163,90 €



1624 Bormax 2.0 prima

Two small Displays (2x7)

Upper	1.	2.	3.	4.	5.	6.	7.	€
1624.								
Ø in mm	15	16	16,2	18	20	22	25	
Qty.	2 pcs.	2 pcs.	2 pcs.	2 pcs.	2 pcs.	2 pcs.	2 pcs.	
€	61,90	61,90	66,00	66,00	66,00	70,20	73,50	465,50 €

Lower	1.	2.	3.	4.	5.	6.	7.	€
1624.								
Ø in mm	30	35	40	45	50	Pre Drill	Brad point.	
Qty.	2 pcs.	2 pcs.	2 pcs.	2 pcs.	2 pcs.	4 pcs.	4 pcs.	
€	82,10	95,80	108,50	138,30	149,20	53,60	44,00	671,50 €

Total 1.137,00 €



1622 Bormax 2.0

One small Display (1x7)

Standard	1.	2.	3.	4.	5.	6.	7.	€
1622.								
Ø in mm	15	20	25	30	35	40	50	
Qty.	2 pcs.	2 pcs.	2 pcs.	2 pcs.	2 pcs.	2 pcs.	2 pcs.	
€	44,00	47,90	55,30	64,00	77,60	90,20	131,00	510,00 €
Total								510,00 €



134

1624 Bormax 2.0 prima

One small Display (1x7)

Standard	1.	2.	3.	4.	5.	6.	7.	€
1624.								
Ø in mm	15	20	25	30	35	40	50	
Qty.	2 pcs.	2 pcs.	2 pcs.	2 pcs.	2 pcs.	2 pcs.	2 pcs.	
€	61,90	66,00	73,50	82,10	95,80	108,50	149,20	637,00 €
Total								637,00 €



1663 TCT Bormax³

One small Display (1x7)

Standard	1.	2.	3.	4.	5.	6.	7.	€
1663.								
Ø in mm	15	20	25	30	35	40	50	
Qty.	2 pcs.	2 pcs.	2 pcs.	2 pcs.	2 pcs.	2 pcs.	2 pcs.	
€	119,00	122,20	125,50	128,80	134,80	160,00	236,60	1.026,90 €
Total								1.026,90 €

1664 TCT Bormax³ prima

One small Display (1x7)

Standard	1.	2.	3.	4.	5.	6.	7.	€
1664								
Ø in mm	15	20	25	30	35	40	50	
Qty.	2 pcs.	2 pcs.	2 pcs.	2 pcs.	2 pcs.	2 pcs.	2 pcs.	
€	136,80	139,90	143,30	146,60	152,60	177,80	254,40	1.151,40 €
Total								1.151,40 €



135

3100 TCT Router bits

One small basis holder (1x6)

Standard	1.	2.	3.	4.	5.	6.	€
3100.							
Ø in mm	3109.825	3101.825	3107.820	3105.890	3104.812	3118.845	
Qty.	1 pcs.	1 pcs.	1 pcs.	1 pcs.	1 pcs.	1 pcs.	
€	59,50	33,05	41,65	31,75	31,75	46,45	244,15 €
Total							244,15 €



3100 TCT Router bits

One Display (3x6)

Standard	1.	2.	3.	4.	5.	6.	€
3100.							
Ø in mm	3107.804	3107.806	3107.810	3107.816	3107.820	3107.825	
Qty.	1 pcs.	1 pcs.	1 pcs.	1 pcs.	1 pcs.	1 pcs.	
€	25,30	25,85	32,10	36,75	41,65	45,35	207,00 €
Medium	1.	2.	3.	4.	5.	6.	€
3100.							
Ø in mm	3107.663	3107.673	3157.625	3101.812	3101.825	3114.831	
Qty.	1 pcs.	1 pcs.	1 pcs.	1 pcs.	1 pcs.	1 pcs.	
€	31,30	51,75	47,50	26,60	33,05	59,75	249,95 €
Deep	1.	2.	3.	4.	5.	6.	€
3100.							
Ø in mm	3109.819	3109.828	3109.831	3109.838	3118.845	3104.812	
Qty.	1 pcs.	1 pcs.	1 pcs.	1 pcs.	1 pcs.	1 pcs.	
€	57,50	61,00	66,45	71,20	46,45	31,75	334,35 €
Total							791,30 €



136

1599 + 1591 Brad Point Drill Bit Mix

One Display (3x8)

Standard	1.	2.	3.	4.	5.	6.	7.	8.	€
1599.1 (L 150 mm)									
Ø in mm	3	4	5	6	7	8	9	10	
Qty.	2 pcs.	2 pcs.	2 pcs.	2 pcs.	2 pcs.	2 pcs.	2 pcs.	2 pcs.	
€	24,80	24,80	26,20	27,80	36,10	36,10	38,30	41,90	256,00 €
Medium	1.	2.	3.	4.	5.	6.	7.	8.	€
1599.2 (L 250 mm)									
Ø in mm	3	4	5	6	8	10	12	14	
Qty.	2 pcs.	2 pcs.	2 pcs.	2 pcs.	2 pcs.	2 pcs.	2 pcs.	2 pcs.	
€	35,70	35,70	40,70	45,60	58,80	71,40	90,60	104,10	482,60 €
Deep	1.	2.	3.	4.	5.	6.	7.	8.	€
1591.									
Ø in mm	3	4	5	6	8	10	12	14	
Qty.	2 pcs.	2 pcs.	2 pcs.	2 pcs.	2 pcs.	2 pcs.	2 pcs.	2 pcs.	
€	9,10	9,30	9,90	10,30	12,00	14,10	21,30	30,00	116,00 €
Total									854,60 €



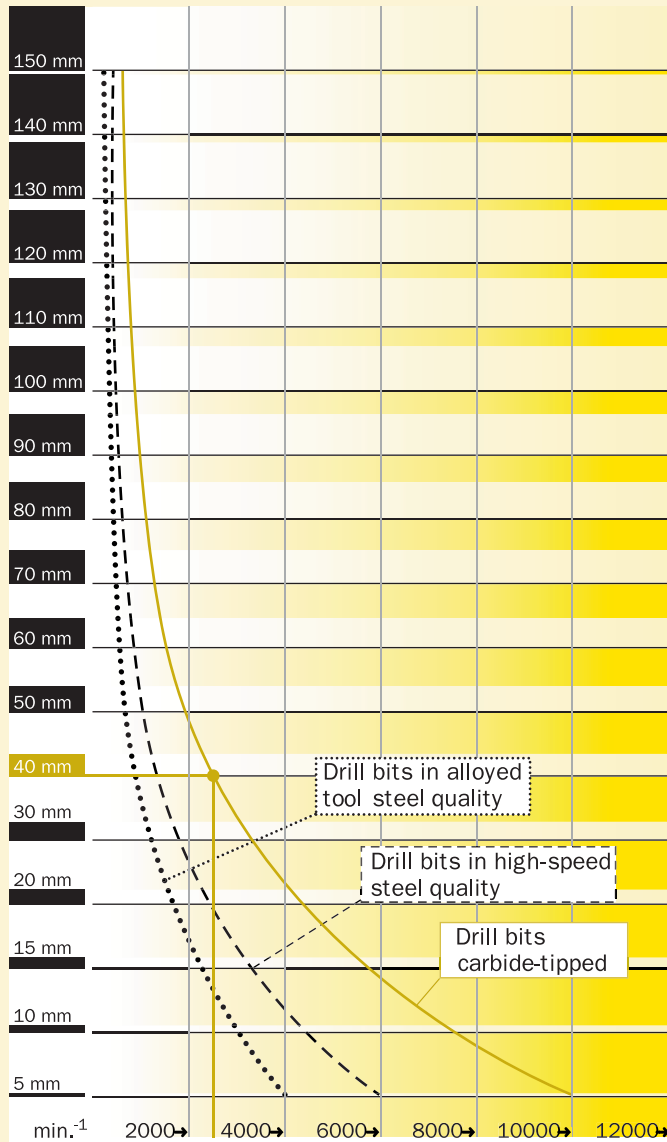

We recommend to select the tool according the material you want to work on. Here are some tips:

Drill bits in alloyed tool steel quality:

Best application in soft woods like spruce, pine and poplar. An exception is the TS-Bormax® drill bit, it can not only be used for soft wood but also for European hardwood and board materials. Good results can also be achieved in soft and medium-hard plastics.

Drill bits in high-speed steel quality: -----

Good application in all soft woods and many hard woods as well as MDF.

Drill bits carbide-tipped: _____

Less suitable for soft woods (exception CT-Bormax³) but ideal for hard woods and exotic hard woods. Very good results in board materials as well as veneer- and plastic-coated panels. Furthermore suitable for drilling in hard plastics.

Please choose the tool material from the three characteristics. The intersection of the graph with the corresponding diameter of the drill bit shows the recommended rpm. Please do not exceed the recommended rpm, because this will have a negative impact on the drilling quality and the service life of the tool.

Example:

For TCT-cylinder boring bit (e.g. product line 1662) Ø 40 mm, the recommendation is an rpm of 2.500.

Different applications require different qualities. In order to make it easier for you, we divide our tools into four main quality categories. A non-professional with the task to drill three holes in poplar wood certainly needs a different tool than for example the furniture industry with its mass production, where thousands of holes have to be drilled in beech wood. Our aim is to meet both requirements with our product range. Therefore the home handy-man should be very satisfied with the result of a 30-mm drill a Forstner bit of the quality level "classic" achieves in soft wood.

Please let you guide by our quality classification or call us: We will be glad to advise you!

○ **quality level Hobby:**

reasonable quality tools for the non-professional segment

○○ **quality level Classic:**

for the quality-conscious user

○○○ **quality level Profi:**

professional tools for the craftsman with high demanding requirements on tool and application

○○○○ **quality level Excellent:**

wear-resistant tools of the highest quality level, even for extreme conditions of use

Information blocks



Subtle distinction



Description of the tool design

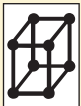

Tool material



Recommended rpm and specific example for the most common diameters in the corresponding field of application



Description of application



Practical advice and specialty of the tool



Packaging unit and information on individual packaging

Abbreviations

Ø	outer diameter
IØ	inner diameter
SØ	shank diameter
L	length of shaft/shank length
OAL	overall length
MC/HS	main cutters
EL	effective length
SPL	spiral length
W	weight
T	teeth
R	radius
∠	degrees
Cutting l.	cutting length
max rpm	maximum acceptable rpm
L1	length of first step (step drill bit)
L2	length of second step (step drill bit)
D1	core diameter
Lead/1"	no. of threads
PU	packing unit

Accessories for Bormax® 2.0 Prima, Long Version	11		
Adjustable Countersink VARIO, TCT	64		
Allen Key and Screws for Ball Bearings Product Line 3191	103		
Auger Bit for Hard Wood	34	Flush Trim Bit, two Flutes	88
Auger Bit with Morse Cone Shank No. 2	32	Formwork Drill Bit, Cylindrical Shank	37
Auger Bit, Lewis Pattern	27	Formwork Drill Bit, HSS	39
	29	Formwork Drill Bit, SDS-Plus Shank	38
	102	Forstner Bit, Classic	17
Ball Bearings for Router Bits	102	Gimlet	124
Beading Bit, Plunge Type, two Flutes	87	Hinge Drill Bit	23
Beading Bit, two Flutes	91	Hole Enlarger, HSS	120
Bevel Trim Bit, two Flutes	90	Keyhole Bit, one Flute	85
	101	Machine Expansive Bit	67
Bi-Metal Hole Saw, HSS-Co, for Roller Shutter	76	Ogee Bit, Plunge Type, two Flutes	87
Bi-Metal Hole Saw for Carpentry, HSS-Co	77	Ogee Fillet Bit, two Flutes	96
Bormax 2.0 Prima (Pilot Guided)	9		97
Bormax® 2.0 Prima, Long Version (Special Counterbore)	10	Panel Pilot Bit with Drilling Point, one Flute	89
Bormax® 2.0, Forstner Bit	6	Panelling Bit, two Flutes	95
Bormax® 2.0, Forstner Bit [INCH]	7	PAROLI 100 Hole Saw for Insulating Material	73
Bormax® 2.0, Forstner Bit, Long Version	8	PAROLI all-around 50, TCT- Universal Hole Saw	71
Brad Point Drill Bit, CV	52	PAROLI all-around 165, TCT-Universal Hole Saw, Long Version	72
Brad Point Drill Bit, CV, Long Version	53	PAROLI Bi-Metal Hole Saw, HSS-Co	74
Brad Point Drill Bit, HSS	50	Piercer/Reaming Awl	122
Brad Point Drill Bit, HSS-G	46	Rabbeting Bit, two Flutes	88
	46	Reversing blade carbide	103
	48	Right-Angle-Driver 90fix	55
	47		108
	57	Roman Ogee Bit, two Flutes	94
	51		96
	92	Rounding Over Bit, two Flutes	91
	93	Screw Auger, Lewis Pattern	36
	90	Set of Cutting Tools for Wooden Threads	122
	95	Slot Mortise Bit	25
	86	Slot Mortise Bit LH	26
	89	Slotting Cutter	82
	86	Solid Carbide Engraving Bit, 3 Flutes	85
	61	Special Adapter	35
	62	Special Auger Bit for Joinery Machines	31
	66	Special Countersink with Lateral Hole, HSS	119
	30	Spiral Slot Milling Cutter	24
	123	Step Drill Bit, Custom Made	59
	66	Step Drill Bit, HSS	58
	119	Step Drill, HSS	120
	60	Straight Bit for Plunging, two Flutes	80
	93	Straight Bit, no Plunge, two Flutes	99
	61		100
	18	Straight Bit, Plunge, one Flute	99
	54	Straight Bit, Staggered, Plunge, two Flutes	100
	41	Straight Bit, Template Profile, two Flutes	82
	19	Straight Bit, two flutes	81
	20	Straight Bit, two Flutes	83
	21	TCT Bormax® Prima (Pilot Guided)	13
	84	TCT-Auger Bit	33
	124	TCT-Bormax®, Forstner Bit	14
	123	TCT-Cylinder Boring Bit	15
	118	TCT-Cylinder Boring Bit, Long Version	16
	65	TCT-Disc + Plug Cutter	21
	63	True Bull Nose Bit, two Flutes	92
	45	Twist Drill Bit, HSS-G, Long Version	107
	58	Twist Drill Bit, HSS-G, Short Version	106
	40	Twist Drill, DIN 1869, HSS-G Co	115
	44	Twist Drill, DIN 338, HSS-G	110
	42	Twist Drill, DIN 338, HSS-G Co	112
	43	Twist Drill, DIN 338, HSS-G Ti Nitrified	109
	63	Twist Drill, Double Sided, HSS-G	118
	22	Twist Drill, HSS-G Co	114
	94	Twist Drill, HSS-G, Long Version	117
	98	Universal Hole Saw, TCT	75
	68	V Groove Bit, two Flutes	84

1001	37	1663	14	3114	88
1002	39	1664	12	3115	89
1005	38	1664	13	3118	90
1014	36	1775	60	3119	91
1403	42	1880	58	3121	96
1403-04-05-06	40	1886	58	3122	97
1404	43	1887	59	3123	92
1405	41	1895	122	3124	93
1406	44	2000/...	122	3125	92
1410	27	2009	123	3127	87
1410	28	2100	62	3131	86
1410	29	2101	66	3134	96
1411	30	2106	66	3135	97
1420	31	2108	54	3137	87
1488/89	35	2115	61	3138	95
1492	32	2152	124	3139	95
1493	34	2155	73	3148	94
1494	33	2160	75	3154	85
1540	67	2166	70	3155	85
1575	45	2166	71	3157	82
1591	50	2169	72	3158	98
1593	51	2170	77	3167	80
1594	46	2173	74	3191	102
1595	47	2174	76	3195	103
1596	56	2202	64	3201	101
1597	57	2410	110	3202	101
1598	55	2420	112	3203	100
1598	108	2430	109	3207	100
1599	48	2440	118	3217	99
1601	25	2450	114	3227	99
1601/03	26	2461	115	3290	103
1607	24	2596	106	3491	53
1614	10	2597	107	3500	52
1616	20	2599	116	3510	68
1616.1	21	2599	117	3514/ 3582	23
1616.2	21	3101	88	3532	61
1619	11	3102	90	3533	123
1621	19	3104	84	3535	118
1622	6	3105	84	3537	62
1622.2	7	3106	86	3540	119
1623	8	3107	81	3541	119
1624	9	3107	83	3572	63
1630	17	3108	82	3573	63
1633	18	3109	91	3577	65
1639	22	3110	89	3685	124
1661	16	3112	93	3690	120
1662	15	3113	94	3692	120

We only make regular deliveries to resellers and/or commercial consumers. The following General Terms and Conditions therefore apply to this group of persons (entrepreneurs) and legal persons under public law or special public assets within the meaning of § 310 (1) of the German Civil Code (BGB). All our offers and purchase and delivery contracts concluded with us are based solely on our General Terms and Conditions. Any deviations from these General Terms and Conditions require our express written approval.

I. Scope of supply

The scope of supply shall be based on our written order confirmation. A deviation from the scope of supply (especially for custom-made articles) shall be permitted as long as there is no major difference from the agreed scope of supply and the deviations are reasonable for the customer. Partial deliveries shall be permitted if they do not lead to any disadvantages regarding use of the goods. During the delivery period, we shall reserve the right to make design and shape changes, which are due to an improvement in the state of the art or to legal requirements, provided the changes in the delivery item are minor and they are reasonable for the customer.

II. Delivery terms/Passing of risk in the case of shipment

(1) When the net value of the goods is less than € 250,- we shall deliver ex works, excluding freight, postage and packing. In the case of small orders with a net goods value less than € 50,- we shall reserve the right to calculate a minimum quantity surcharge. When the net value of the goods exceeds € 250,- we shall deliver from Germany free destination (receiving station) or free German frontier, including freight, postage, packing (excluding carriage and local delivery charges, as well as costs for incidental charges such as couriers, express delivery, cash on delivery, etc., which shall be calculated separately). This shall not include drill rigs, soil augers and accessories, which shall always be delivered ex works, excluding freight, postage and packing. This provision shall also apply to other goods with a heavier weight and larger dimensions, which do not form part of our normal drill and tool product range. When the net value of the goods is more than € 1,500,- we shall deliver FOB German airport or port.

(2) In the case of deliveries from our depots, we shall levy a reasonable surcharge for prior carriage charges and warehouse service (maximum 5% of the net goods value). Packaging shall become the property of the customer and shall be charged by our company. Postage and packing costs shall be invoiced separately.

(3) The dispatch method shall be chosen at our best discretion. When the goods are sent to the customer, but at the latest when they leave the factory/warehouse, risk of accidental loss or accidental deterioration of

the goods shall pass to the customer, irrespective of whether delivery is effected by our company or a third party commissioned by us, and irrespective of who pays the freight costs. Transport insurance shall only be provided at the express request of the customer and in return for payment. Transport damage shall be reported immediately to the carrier.

(4) In the case of direct delivery to third parties (for example to the customer of the customer) we charge a service fee of 7.50 euros per order plus shipping costs.

(5) In the case of an express delivery, the order must be submitted by 12:30 hrs to guarantee the same day delivery.

III. Prices and price changes

(1) All prices shall be shown in Euro per unit (piece, set, etc.) plus statutory VAT.

(2) Price changes after conclusion of the contract shall be permitted if a period of more than three months has elapsed between the date of conclusion of the contract and the agreed delivery date. If wages, material costs, sales costs or market cost prices then rise before completion of the delivery, we shall be entitled to increase the price by a reasonable amount based on the cost increases.

IV. Payment terms

Our invoices shall become due for payment within 10 days less 2% discount or in 30 days after delivery without any deductions. Invoices under € 50,- shall become due for payment immediately without any deductions. If the customer fails to pay on time, default interest amounting to 8% above the basic interest rate shall become due in accordance with § 247 of the German Civil Code (BGB). We shall expressly reserve the right to enforce a claim for further damage. Payments made by cheque or bill of exchange shall only be considered as made when honoured.

V. Reservation of title

(1) We shall reserve title to the supplied goods until all claims from the delivery contract have been paid in full. If the customer infringes the contract, in particular by delays in payment, we shall be entitled to recover the goods after issuing a warning. The customer shall be obliged to return the goods in this case. Assertion of the reservation of title and recovery of the delivery items by us shall not be regarded as withdrawal from the contract.

(2) The customer shall be entitled to resell the delivery items in the ordinary course of business. However, the customer shall now assign to us all claims amounting to the purchase price (including VAT) agreed between our company and the customer, which accrue to the

customer through resale of the goods, i.e. irrespective of whether the delivery items are resold without processing or after processing. The customer shall be empowered to collect this claim after its assignment. Our authority to personally collect the claims shall not be affected as long as the customer duly complies with his payment obligations and is not in default of payment. If this is the case, however, we may request the customer to stipulate the assigned claims and their debtors, provide all the information required for collection, hand over the related documents and inform the debtors (third parties) about assignment.

(3) We shall reserve the right to withdraw from the contract or terminate our obligation to perform if we become aware of a currently existing or future poor financial situation of the customer.

VI. Warranty

(1) Warranty claims by the customer shall presuppose that he has duly complied with his obligation to inspect the goods and notify defects in accordance with § 377 of the German Commercial Code (HGB).

(2) Defect claims by the customer shall become statutebarred in 12 months after acceptance of the delivery item. The above provisions shall not apply if longer periods are legally prescribed in § 438 (1) No. 2, § 479 (1) and § 634a (1) of the German Civil Code (BGB). Our permission shall be obtained before goods are returned at any time.

(3) If, despite all care being taken by our company, the delivered goods contain a defect which already existed at the time that risk was passed, we shall have the choice of either reworking the goods or delivering replacement goods subject to receiving notification of the defect in good time. We shall always be given the opportunity to effect supplementary performance within a reasonable period of time. Recourse claims shall remain unaffected by the above provision without restriction.

(4) If we are unable to rectify a defect covered by our warranty obligation or if additional rework attempts are unreasonable for the customer, the customer may request – irrespective of any compensation claims – withdrawal from the contract or a reduction in the purchase price instead of rework.

(5) Defect claims shall not arise if there is only a slight deviation from the agreed state of the goods or if their usability is only slightly impaired. Defect claims shall also not arise in the case of natural wear or tear and with damage which occurs after passing of risk due to incorrect or negligent handling, excessive force or special external influences which are not covered by the contract.

(6) Claims by the customer in connection with expenses required for the purpose of supplementary performance, especially transport costs, travelling expenses,

labour costs or material costs, shall be excluded if the expenses increase because the goods supplied by our company were brought later to a place other than the customer's branch, unless the movement of the goods corresponds to their intended use.

(7) Recourse claims by the customer against our company shall only arise if the customer has not concluded any agreements over and beyond legally compelling defect claims with his customer. Subparagraph 6 shall apply analogously to the amount of the customer's recourse claim.

(8) Unless the claims relate to death, physical injury or damage to health, our liability shall only extend to cases of intent and gross negligence. This provision shall also apply to compensation claims for damages in tort and to actions by our subcontractors and vicarious agents.

VII. Place of performance and place of jurisdiction

The place of performance and place of jurisdiction for all participating contracting parties shall be Remscheid. German law shall apply to the exclusion of the UN Convention on the International Sale of Goods, even if the customer's head office is outside Germany.

VIII. Miscellaneous

If individual clauses of these General Terms and Conditions are or become invalid, or if they contain a loophole, the validity of the other clauses shall not be affected.



Custom-made products, special requests, extraordinary requirements or particular, individual tasks? We are at your service!

144

As an experienced manufacturer and specialist with a long tradition and a philosophy that is committed to customer needs and high quality demands, we offer you a competent and expert support in all application questions that arise.

So if you do not find the appropriate tool among our product range, please contact us!

Go ahead and describe the exact application – together we will come to a solution. This can either be a combination of standard tools or a special custom-made tool, which will be designed according to your individual requirements.

If it is possible to fulfil your task by one of our standard tools, quick help can be provided because most of our 4,500 quality tools are available on stock. If not, we dedicate ourselves with all our competence to the realization of custom-made products, special requests and extraordinary requirements. In this case the delivery time will take a little bit longer depending on the extent and effort. A sketch, a pattern or a drawing always leads to a better understanding and simplifies production process.

An important parameter that determines the price is the quantity. This also applies to the realization of changes in shaft, special shafts and measurements concerning our standard tools.

By the way, auger bits can be produced up to a diameter of 80 mm on our CNC-machines. With our latest machine even a spiral length up to 2,500 mm is possible.

For step drill bits we prepared an enquiry form concerning the series of articles No. 1887 on page 59. Please do not forget to state the desired quantity here as well!

Our specialists support you with regard to all technical questions. Just call us, we will be glad to advise you!

**FAMAG-Werkzeugfabrik
GmbH & Co. KG
Rather Straße 29
42855 Remscheid, Germany**

**Telefon: +49 (2191) 9284-0
Telefax: +49 (2191) 9284-20
email: info@famag.com
www.famag.com**



Interior:
A pair of diagonal staggered
metal teeth for perfect power
transmission up to 50 Nm!



90fix Right-Angle-Driver

Art.-No.: 1598.750 on page 55



40

Construction depth:
40 mm construction depth allows to
drill/ screw in inaccessible areas

125

A strong magnet supports the
holder for the 1/4 inch bits



FAMAG®

... *a cut above*



2166
page 70



1664
page 12



1598
page 55



1403
page 40



The subtle difference
page 4

www.famag.com

FAMAG-Werkzeugfabrik GmbH & Co. KG | Rather Str. 29 | 42855 Remscheid | Germany
Phone +49 (2191) 92840 | Fax +49 (2191) 928420 | E-Mail: info@famag.com